

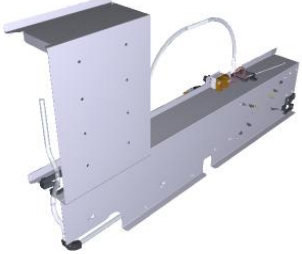





Assembly code	Assembly revision	Assembly image
ASM3442B/0.D00	Electrical system	
ASM3406B/0.D00	Cooking chamber	
ASM3418A/0.D02	External cover	
ASM3435A/0.D01	Door	

ASM3442B/0.D00 - Electrical system

FRONT

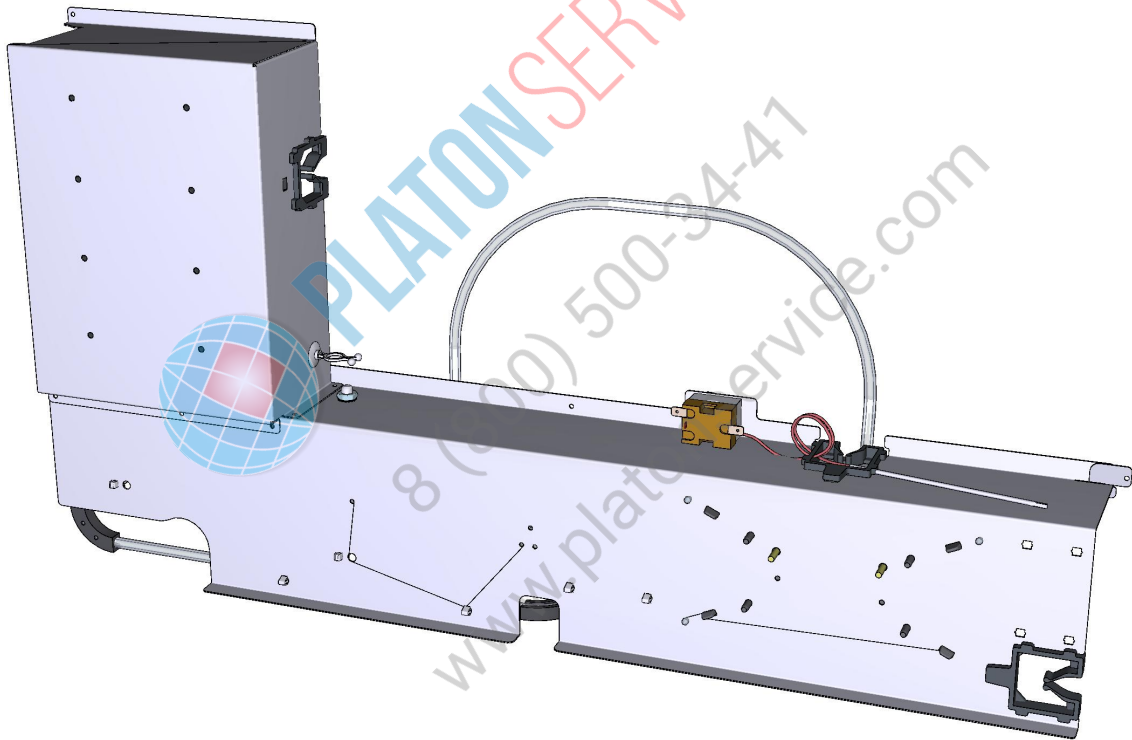

ASM3442B/0.D00 - Electrical system

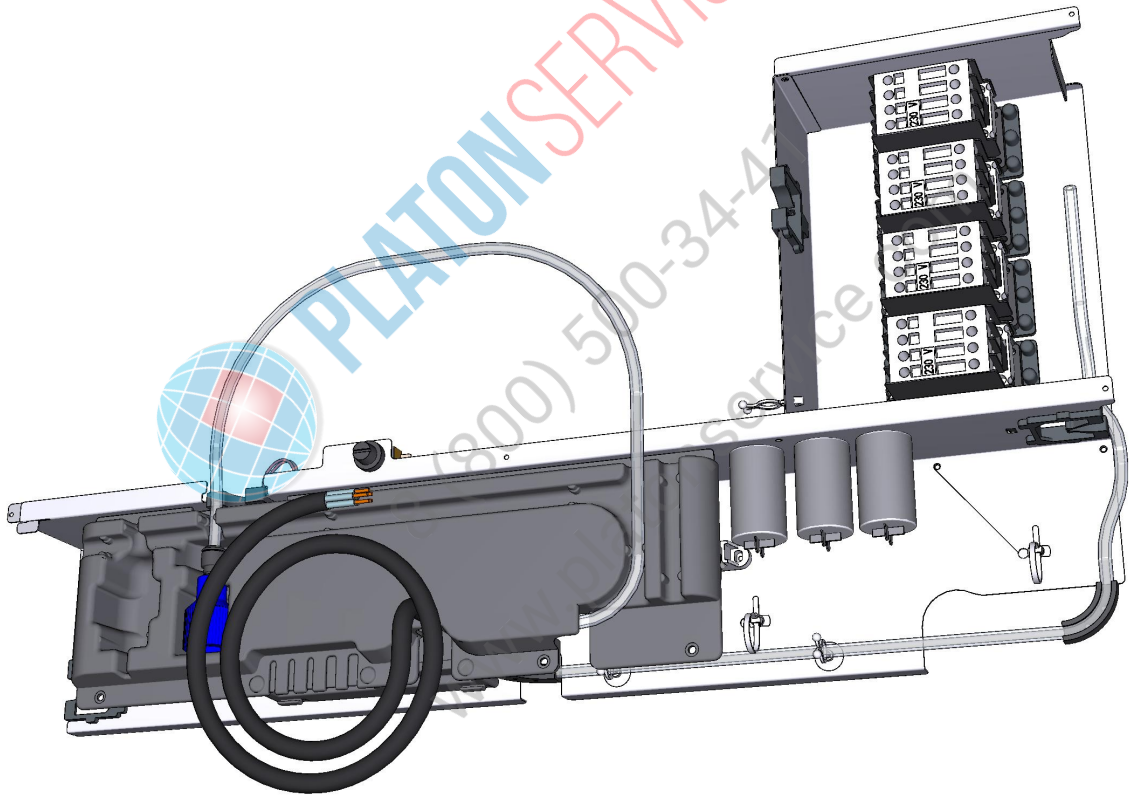

REAR



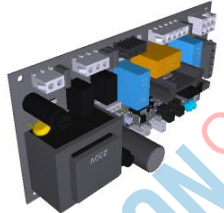
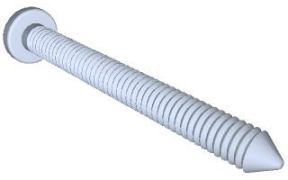

COMPONENT			SPARE PART																										
Code	Description	Image	Code	Description	Components list																								
TR1136A	330 °C 1 POLE SAFETY THERMOSTAT		KTR1136A	330 °C SAFETY THERMOSTAT KIT	<table border="1"> <thead> <tr> <th>Code</th> <th>Description</th> <th>Qty</th> <th>UOM</th> </tr> </thead> <tbody> <tr> <td>0H7030A0</td> <td>THERMOSTAT BULB INLET COVER</td> <td>1</td> <td>PZ</td> </tr> <tr> <td>GN1531A0</td> <td>THERMOSTAT BULB INLET SEALING</td> <td>1</td> <td>PZ</td> </tr> <tr> <td>SL1045A0</td> <td>S57 BLACK SILICONE - 80ML CARTRIDGE</td> <td>1</td> <td>PZ</td> </tr> <tr> <td>TR1136A0</td> <td>330 °C 1 POLE SAFETY THERMOSTAT</td> <td>1</td> <td>PZ</td> </tr> <tr> <td>VI1220A1</td> <td>4,2X12 TCB SELF-TAPPING SCREW</td> <td>3</td> <td>PZ</td> </tr> </tbody> </table>	Code	Description	Qty	UOM	0H7030A0	THERMOSTAT BULB INLET COVER	1	PZ	GN1531A0	THERMOSTAT BULB INLET SEALING	1	PZ	SL1045A0	S57 BLACK SILICONE - 80ML CARTRIDGE	1	PZ	TR1136A0	330 °C 1 POLE SAFETY THERMOSTAT	1	PZ	VI1220A1	4,2X12 TCB SELF-TAPPING SCREW	3	PZ
Code	Description	Qty	UOM																										
0H7030A0	THERMOSTAT BULB INLET COVER	1	PZ																										
GN1531A0	THERMOSTAT BULB INLET SEALING	1	PZ																										
SL1045A0	S57 BLACK SILICONE - 80ML CARTRIDGE	1	PZ																										
TR1136A0	330 °C 1 POLE SAFETY THERMOSTAT	1	PZ																										
VI1220A1	4,2X12 TCB SELF-TAPPING SCREW	3	PZ																										
CN1003A	6,3 UF MOTOR CAPACITOR		KCN1003A	6,3 UF MOTOR CAPACITOR KIT	<table border="1"> <thead> <tr> <th>Code</th> <th>Description</th> <th>Qty</th> <th>UOM</th> </tr> </thead> <tbody> <tr> <td>CN1003A0</td> <td>6,3 UF MOTOR CAPACITOR</td> <td>1</td> <td>PZ</td> </tr> <tr> <td>VI1931A0</td> <td>M8 NUT+INDENTE D WASHER D=8 X COND.</td> <td>1</td> <td>PZ</td> </tr> <tr> <td>VI1932A0</td> <td>M8 NUT+INDENTE D WASHER D=8 X COND.</td> <td>1</td> <td>PZ</td> </tr> <tr> <td>VM1224A0</td> <td></td> <td>0.200</td> <td>M</td> </tr> </tbody> </table>	Code	Description	Qty	UOM	CN1003A0	6,3 UF MOTOR CAPACITOR	1	PZ	VI1931A0	M8 NUT+INDENTE D WASHER D=8 X COND.	1	PZ	VI1932A0	M8 NUT+INDENTE D WASHER D=8 X COND.	1	PZ	VM1224A0		0.200	M				
Code	Description	Qty	UOM																										
CN1003A0	6,3 UF MOTOR CAPACITOR	1	PZ																										
VI1931A0	M8 NUT+INDENTE D WASHER D=8 X COND.	1	PZ																										
VI1932A0	M8 NUT+INDENTE D WASHER D=8 X COND.	1	PZ																										
VM1224A0		0.200	M																										
RC1006A	D8 PET PIPE GUIDE BEND		KRC1006A	20 PCS. Ø8 PET PIPE GUIDE BEND KIT	<table border="1"> <thead> <tr> <th>Code</th> <th>Description</th> <th>Qty</th> <th>UOM</th> </tr> </thead> <tbody> <tr> <td>RC1006A0</td> <td>D8 PET PIPE GUIDE BEND</td> <td>20</td> <td>PZ</td> </tr> <tr> <td>VM1224A0</td> <td></td> <td>0.200</td> <td>M</td> </tr> </tbody> </table>	Code	Description	Qty	UOM	RC1006A0	D8 PET PIPE GUIDE BEND	20	PZ	VM1224A0		0.200	M												
Code	Description	Qty	UOM																										
RC1006A0	D8 PET PIPE GUIDE BEND	20	PZ																										
VM1224A0		0.200	M																										
MR1004A	41A 450V 7 POLES TERMINAL		KMR1004A	7FTW 1+2+3/4+5+6 TERMINAL BLOCK KIT	<table border="1"> <thead> <tr> <th>Code</th> <th>Description</th> <th>Qty</th> <th>UOM</th> </tr> </thead> <tbody> <tr> <td>MR1004A1</td> <td>41A 450V 7 POLES TERMINAL</td> <td>1</td> <td>PZ</td> </tr> <tr> <td>VM1224A0</td> <td></td> <td>0.300</td> <td>M</td> </tr> </tbody> </table>	Code	Description	Qty	UOM	MR1004A1	41A 450V 7 POLES TERMINAL	1	PZ	VM1224A0		0.300	M												
Code	Description	Qty	UOM																										
MR1004A1	41A 450V 7 POLES TERMINAL	1	PZ																										
VM1224A0		0.300	M																										

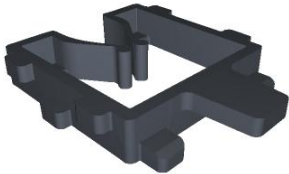
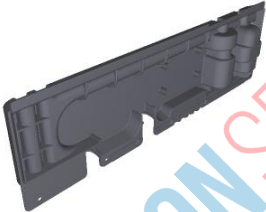
COMPONENT			SPARE PART																						
Code	Description	Image	Code	Description	Components list																				
VM2191A	VE1095 BIG SWITCH BRACKET		VM2191A0	VE1095 BIG SWITCH BRACKET																					
VE1095A	GE 25A 230V REMOTE CONTROL SWITCH		KVE1095A	HEATING ELEMENT CONTACTOR KIT	<table border="1"> <thead> <tr> <th>Code</th> <th>Description</th> <th>Qty</th> <th>UOM</th> </tr> </thead> <tbody> <tr> <td>VE1095A0</td> <td>GE 25A 230V REMOTE CONTROL SWITCH</td> <td>1</td> <td>PZ</td> </tr> <tr> <td>VM1075A1</td> <td>PLASTIC CLIP TO FIX CONTACTORS</td> <td>4</td> <td>PZ</td> </tr> <tr> <td>VM1224A0</td> <td></td> <td>0.250</td> <td>M</td> </tr> </tbody> </table>	Code	Description	Qty	UOM	VE1095A0	GE 25A 230V REMOTE CONTROL SWITCH	1	PZ	VM1075A1	PLASTIC CLIP TO FIX CONTACTORS	4	PZ	VM1224A0		0.250	M				
Code	Description	Qty	UOM																						
VE1095A0	GE 25A 230V REMOTE CONTROL SWITCH	1	PZ																						
VM1075A1	PLASTIC CLIP TO FIX CONTACTORS	4	PZ																						
VM1224A0		0.250	M																						
CE1460A	5X4MMQ H07RN-F L=1,8MT CABLE		OUTOFPRODUCTIO																						
RC1002A	JG 10M-8F TERMINAL REDUCTION FITTIN		KRC1002A	G Ø10M-Ø8F REDUCING SPIGOT 10 PCS KIT	<table border="1"> <thead> <tr> <th>Code</th> <th>Description</th> <th>Qty</th> <th>UOM</th> </tr> </thead> <tbody> <tr> <td>RC1002A0</td> <td>JG 10M-8F TERMINAL REDUCTION FITTING</td> <td>10</td> <td>PZ</td> </tr> <tr> <td>VM1224A0</td> <td></td> <td>0.200</td> <td>M</td> </tr> </tbody> </table>	Code	Description	Qty	UOM	RC1002A0	JG 10M-8F TERMINAL REDUCTION FITTING	10	PZ	VM1224A0		0.200	M								
Code	Description	Qty	UOM																						
RC1002A0	JG 10M-8F TERMINAL REDUCTION FITTING	10	PZ																						
VM1224A0		0.200	M																						
RC1365A	3/4"-10 JG FEMALE CONNECTION		KRC1365A	3/4"-10 OR 8 JG WATER CONNECTION KIT	<table border="1"> <thead> <tr> <th>Code</th> <th>Description</th> <th>Qty</th> <th>UOM</th> </tr> </thead> <tbody> <tr> <td>GN1200A1</td> <td>3/4 CONNECTION SEAL D=24 RUBBER+NET</td> <td>1</td> <td>PZ</td> </tr> <tr> <td>RC1002A0</td> <td>JG 10M-8F TERMINAL REDUCTION FITTING</td> <td>1</td> <td>PZ</td> </tr> <tr> <td>RC1365A0</td> <td>3/4"-10 JG FEMALE CONNECTION</td> <td>1</td> <td>PZ</td> </tr> <tr> <td>VM1224A0</td> <td></td> <td>0.150</td> <td>M</td> </tr> </tbody> </table>	Code	Description	Qty	UOM	GN1200A1	3/4 CONNECTION SEAL D=24 RUBBER+NET	1	PZ	RC1002A0	JG 10M-8F TERMINAL REDUCTION FITTING	1	PZ	RC1365A0	3/4"-10 JG FEMALE CONNECTION	1	PZ	VM1224A0		0.150	M
Code	Description	Qty	UOM																						
GN1200A1	3/4 CONNECTION SEAL D=24 RUBBER+NET	1	PZ																						
RC1002A0	JG 10M-8F TERMINAL REDUCTION FITTING	1	PZ																						
RC1365A0	3/4"-10 JG FEMALE CONNECTION	1	PZ																						
VM1224A0		0.150	M																						

COMPONENT			SPARE PART																														
Code	Description	Image	Code	Description	Components list																												
VM1187A	POWER BOARD FRAME SHOP.PRO		VM1187A0	POWER BOARD FRAME SHOP.PRO																													
PE2102A	BL LED/TOUCH/PLUS 230 V POWER CARD		KPE2102A	BL LED/TOUCH/MASTE R 230V POWER CARD KIT	<table border="1"> <thead> <tr> <th>Code</th> <th>Description</th> <th>Qty</th> <th>UOM</th> </tr> </thead> <tbody> <tr> <td>PE2102A0</td> <td>BL LED/TOUCH/P LUS 230V POWER BOARD KIT</td> <td>1</td> <td>PZ</td> </tr> <tr> <td>PE2102A1</td> <td>BL LED/TOUCH/P LUS 230 V POWER CARD</td> <td>1</td> <td>PZ</td> </tr> <tr> <td>PE2102A2</td> <td>BL LED/TOUCH/P LUS 230V POWER BOAR</td> <td>1</td> <td>PZ</td> </tr> <tr> <td>VI1988A0</td> <td>AUTOTHREAD ING SCREW 4,2X19 TCB+ INOX</td> <td>3</td> <td>PZ</td> </tr> <tr> <td>VM1187A0</td> <td>POWER BOARD FRAME SHOP.PRO</td> <td>1</td> <td>PZ</td> </tr> <tr> <td>VM2147A0</td> <td>410X343X15 MM PINK SMOOTH ESD SPONGE</td> <td>1</td> <td>PZ</td> </tr> </tbody> </table>	Code	Description	Qty	UOM	PE2102A0	BL LED/TOUCH/P LUS 230V POWER BOARD KIT	1	PZ	PE2102A1	BL LED/TOUCH/P LUS 230 V POWER CARD	1	PZ	PE2102A2	BL LED/TOUCH/P LUS 230V POWER BOAR	1	PZ	VI1988A0	AUTOTHREAD ING SCREW 4,2X19 TCB+ INOX	3	PZ	VM1187A0	POWER BOARD FRAME SHOP.PRO	1	PZ	VM2147A0	410X343X15 MM PINK SMOOTH ESD SPONGE	1	PZ
Code	Description	Qty	UOM																														
PE2102A0	BL LED/TOUCH/P LUS 230V POWER BOARD KIT	1	PZ																														
PE2102A1	BL LED/TOUCH/P LUS 230 V POWER CARD	1	PZ																														
PE2102A2	BL LED/TOUCH/P LUS 230V POWER BOAR	1	PZ																														
VI1988A0	AUTOTHREAD ING SCREW 4,2X19 TCB+ INOX	3	PZ																														
VM1187A0	POWER BOARD FRAME SHOP.PRO	1	PZ																														
VM2147A0	410X343X15 MM PINK SMOOTH ESD SPONGE	1	PZ																														
VI1328A			VI1328A0																														

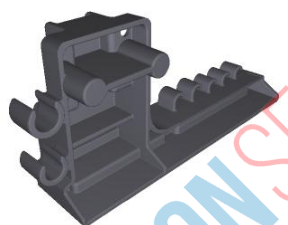
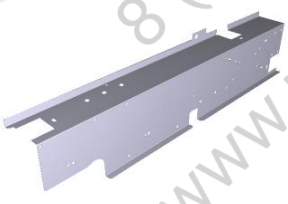
COMPONENT			SPARE PART																										
Code	Description	Image	Code	Description	Components list																								
VM1188A	BL SHOP.PRO POWER BOARD WIRE PASSAGE		VM1188A0	BL SHOP.PRO POWER BOARD WIRE PASSAGE																									
VM2483A	COMPONENTS HOLDER COVER SHOP.PRO		KVM2483A	BL SHOP.PRO COMPONENTS HOLDER COVER KIT	<table border="1"> <thead> <tr> <th>Code</th> <th>Description</th> <th>Qty</th> <th>UOM</th> </tr> </thead> <tbody> <tr> <td>VM1224A0</td> <td></td> <td>0.300</td> <td>M</td> </tr> <tr> <td>VM2483A0</td> <td>COMPONENT S HOLDER COVER SHOP.PRO</td> <td>1</td> <td>PZ</td> </tr> <tr> <td>VM2483A0</td> <td>COMPONENT S HOLDER COVER SHOP.PRO</td> <td>1</td> <td>PZ</td> </tr> <tr> <td>VM2483A1</td> <td>SHOP PRO COMPONENT S HOLDER COVER</td> <td>1</td> <td>PZ</td> </tr> </tbody> </table>	Code	Description	Qty	UOM	VM1224A0		0.300	M	VM2483A0	COMPONENT S HOLDER COVER SHOP.PRO	1	PZ	VM2483A0	COMPONENT S HOLDER COVER SHOP.PRO	1	PZ	VM2483A1	SHOP PRO COMPONENT S HOLDER COVER	1	PZ				
Code	Description	Qty	UOM																										
VM1224A0		0.300	M																										
VM2483A0	COMPONENT S HOLDER COVER SHOP.PRO	1	PZ																										
VM2483A0	COMPONENT S HOLDER COVER SHOP.PRO	1	PZ																										
VM2483A1	SHOP PRO COMPONENT S HOLDER COVER	1	PZ																										
VM2484A	ELECTRICAL CONNECTION CABLE CLAMP		KVM2484A	CABLE LOCKS ELECTRICAL CONNECTION KIT	<table border="1"> <thead> <tr> <th>Code</th> <th>Description</th> <th>Qty</th> <th>UOM</th> </tr> </thead> <tbody> <tr> <td>VM1224A0</td> <td></td> <td>0.300</td> <td>M</td> </tr> <tr> <td>VM2484A0</td> <td>ELECTRICAL CONNECTION CABLE CLAMP</td> <td>1</td> <td>PZ</td> </tr> <tr> <td>VM2484A0</td> <td>ELECTRICAL CONNECTION CABLE CLAMP</td> <td>1</td> <td>PZ</td> </tr> </tbody> </table>	Code	Description	Qty	UOM	VM1224A0		0.300	M	VM2484A0	ELECTRICAL CONNECTION CABLE CLAMP	1	PZ	VM2484A0	ELECTRICAL CONNECTION CABLE CLAMP	1	PZ								
Code	Description	Qty	UOM																										
VM1224A0		0.300	M																										
VM2484A0	ELECTRICAL CONNECTION CABLE CLAMP	1	PZ																										
VM2484A0	ELECTRICAL CONNECTION CABLE CLAMP	1	PZ																										
			KVM2482A	BAKERLUX SP ELECTR COMPONENTS HOLDER KIT	<table border="1"> <thead> <tr> <th>Code</th> <th>Description</th> <th>Qty</th> <th>UOM</th> </tr> </thead> <tbody> <tr> <td>VM1224A0</td> <td></td> <td>0.300</td> <td>M</td> </tr> <tr> <td>VM2482A0</td> <td>ELECTR COMPONENT S HOLDER FRAME SHOP.PRO</td> <td>1</td> <td>PZ</td> </tr> <tr> <td>VM2482A0</td> <td>ELECTR COMPONENT S HOLDER FRAME SHOP.PRO</td> <td>1</td> <td>PZ</td> </tr> <tr> <td>VM2484A0</td> <td>ELECTRICAL CONNECTION CABLE CLAMP</td> <td>1</td> <td>PZ</td> </tr> <tr> <td>VM2484A0</td> <td>ELECTRICAL CONNECTION CABLE CLAMP</td> <td>1</td> <td>PZ</td> </tr> </tbody> </table>	Code	Description	Qty	UOM	VM1224A0		0.300	M	VM2482A0	ELECTR COMPONENT S HOLDER FRAME SHOP.PRO	1	PZ	VM2482A0	ELECTR COMPONENT S HOLDER FRAME SHOP.PRO	1	PZ	VM2484A0	ELECTRICAL CONNECTION CABLE CLAMP	1	PZ	VM2484A0	ELECTRICAL CONNECTION CABLE CLAMP	1	PZ
Code	Description	Qty	UOM																										
VM1224A0		0.300	M																										
VM2482A0	ELECTR COMPONENT S HOLDER FRAME SHOP.PRO	1	PZ																										
VM2482A0	ELECTR COMPONENT S HOLDER FRAME SHOP.PRO	1	PZ																										
VM2484A0	ELECTRICAL CONNECTION CABLE CLAMP	1	PZ																										
VM2484A0	ELECTRICAL CONNECTION CABLE CLAMP	1	PZ																										

COMPONENT			SPARE PART																										
Code	Description	Image	Code	Description	Components list																								
TB3283A			KTB1959A	7,93X4,75 PE TRANSPARENT PIPE 5M KIT	<table border="1"> <thead> <tr> <th>Code</th> <th>Description</th> <th>Qty</th> <th>UOM</th> </tr> </thead> <tbody> <tr> <td>TB1815A0</td> <td>7,93X4,75 PE TRANSP. PIPE (JG #PE08100N)</td> <td>5</td> <td>M</td> </tr> </tbody> </table>	Code	Description	Qty	UOM	TB1815A0	7,93X4,75 PE TRANSP. PIPE (JG #PE08100N)	5	M																
Code	Description	Qty	UOM																										
TB1815A0	7,93X4,75 PE TRANSP. PIPE (JG #PE08100N)	5	M																										
VM2482A	ELECTR COMPONENTS HOLDER FRAME SHOP.PRO		KVM2482A	BAKERLUX SP ELECTR COMPONENTS HOLDER KIT	<table border="1"> <thead> <tr> <th>Code</th> <th>Description</th> <th>Qty</th> <th>UOM</th> </tr> </thead> <tbody> <tr> <td>VM1224A0</td> <td></td> <td>0.300</td> <td>M</td> </tr> <tr> <td>VM2482A0</td> <td>ELECTR COMPONENT S HOLDER FRAME SHOP.PRO</td> <td>1</td> <td>PZ</td> </tr> <tr> <td>VM2482A0</td> <td>ELECTR COMPONENT S HOLDER FRAME SHOP.PRO</td> <td>1</td> <td>PZ</td> </tr> <tr> <td>VM2484A0</td> <td>ELECTRICAL CONNECTION CABLE CLAMP</td> <td>1</td> <td>PZ</td> </tr> <tr> <td>VM2484A0</td> <td>ELECTRICAL CONNECTION CABLE CLAMP</td> <td>1</td> <td>PZ</td> </tr> </tbody> </table>	Code	Description	Qty	UOM	VM1224A0		0.300	M	VM2482A0	ELECTR COMPONENT S HOLDER FRAME SHOP.PRO	1	PZ	VM2482A0	ELECTR COMPONENT S HOLDER FRAME SHOP.PRO	1	PZ	VM2484A0	ELECTRICAL CONNECTION CABLE CLAMP	1	PZ	VM2484A0	ELECTRICAL CONNECTION CABLE CLAMP	1	PZ
Code	Description	Qty	UOM																										
VM1224A0		0.300	M																										
VM2482A0	ELECTR COMPONENT S HOLDER FRAME SHOP.PRO	1	PZ																										
VM2482A0	ELECTR COMPONENT S HOLDER FRAME SHOP.PRO	1	PZ																										
VM2484A0	ELECTRICAL CONNECTION CABLE CLAMP	1	PZ																										
VM2484A0	ELECTRICAL CONNECTION CABLE CLAMP	1	PZ																										
0P1023B	COMPONENTS HOLDING PANEL VIT-CAM SP		0P1023B0	COMPONENTS HOLDING PANEL VIT-CAM SP																									
0P1024B	CONTACTOR HOLDER VIT-CAM S		0P1024B0	CONTACTOR HOLDER VIT-CAM S																									







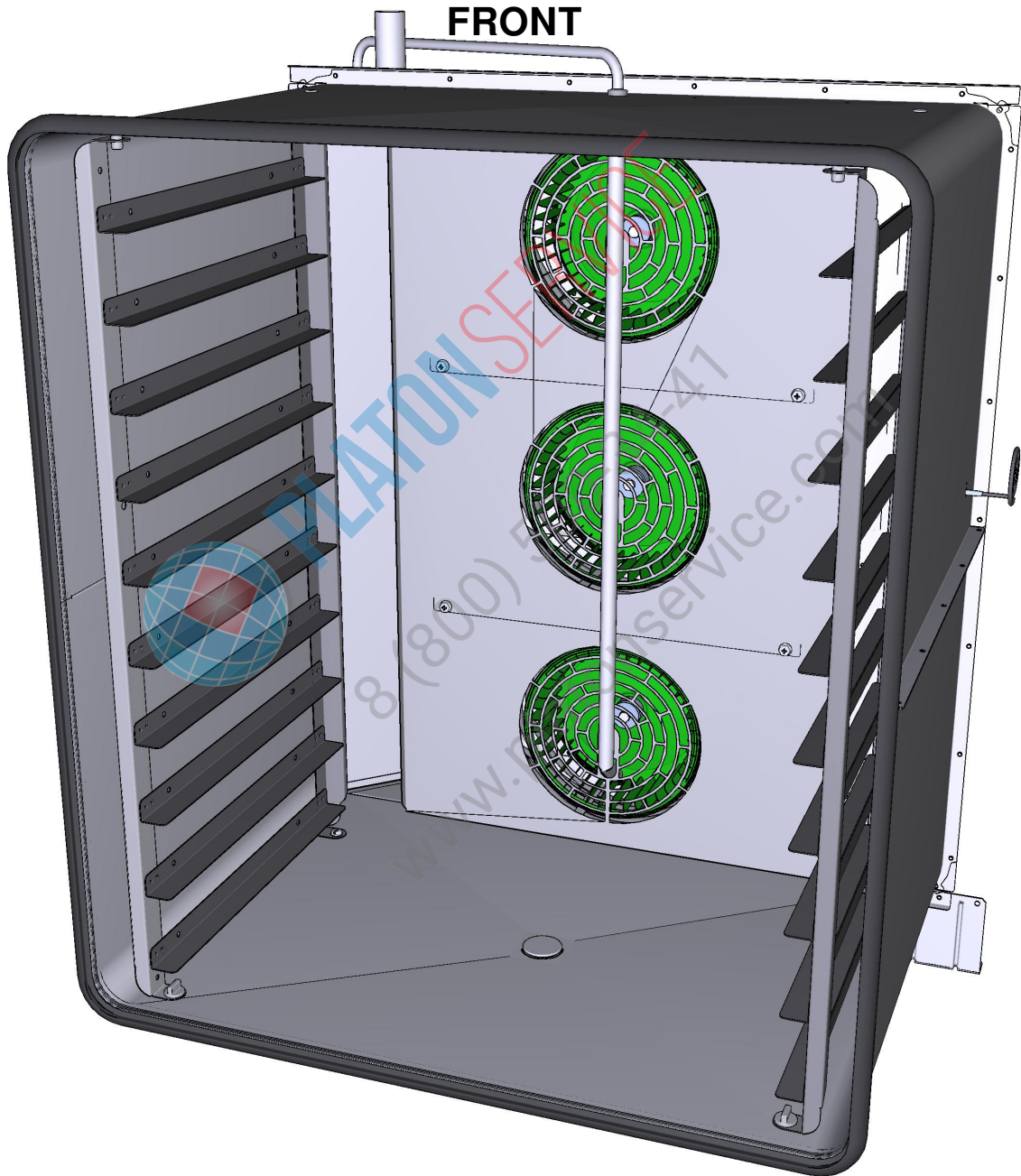

ASM3406B/0.D00 - Cooking chamber



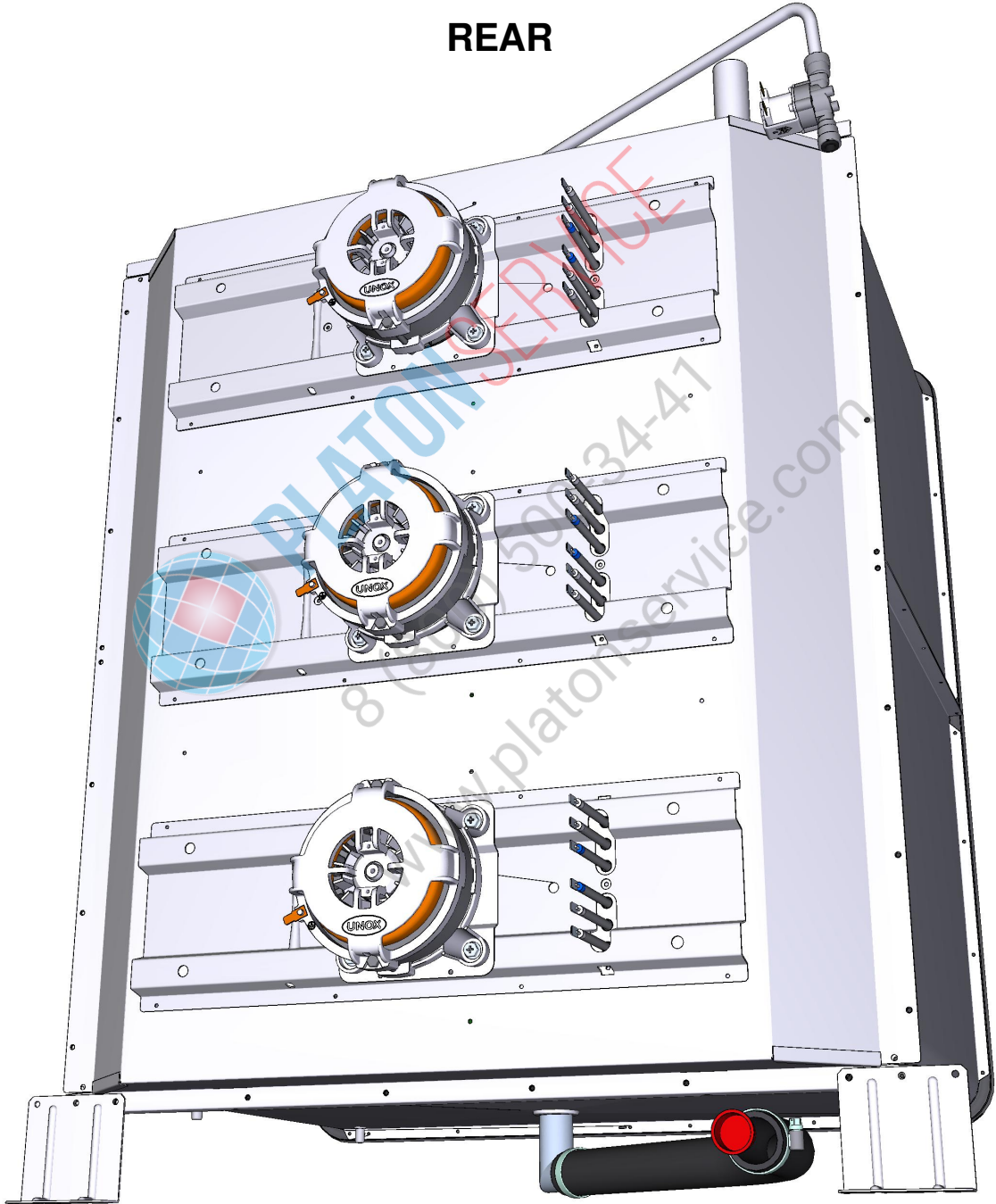

ASM3406B/0.D00 - Cooking chamber

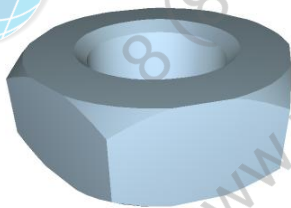

REAR

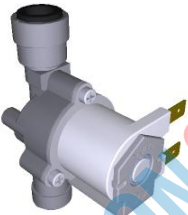

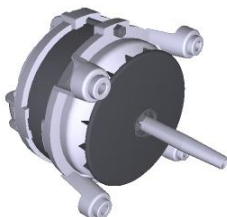
COMPONENT			SPARE PART																																										
Code	Description	Image	Code	Description	Components list																																								
TR1105A			KTR1105A	PT100 L1000 TEMPERATURE PROBE KIT	<table border="1"> <thead> <tr> <th>Code</th> <th>Description</th> <th>Qty</th> <th>UOM</th> </tr> </thead> <tbody> <tr> <td>GN1120A0</td> <td>TEMPERATUR E PROBE NTC SEAL</td> <td>1</td> <td>PZ</td> </tr> <tr> <td>GN1120A1</td> <td></td> <td>1</td> <td>PZ</td> </tr> <tr> <td>GN1285A0</td> <td>NTC TEMPERATUR E PROBE SEALING</td> <td>1</td> <td>PZ</td> </tr> <tr> <td>SL1045A0</td> <td>S57 BLACK SILICONE - 80ML CARTRIDGE</td> <td>1</td> <td>PZ</td> </tr> <tr> <td>TR1105A4</td> <td></td> <td>1</td> <td>PZ</td> </tr> <tr> <td>VI1220A1</td> <td>4,2X12 TCB SELF-TAPPIN G SCREW</td> <td>2</td> <td>PZ</td> </tr> <tr> <td>VM1464A1</td> <td>CT BT TEMPERATUR E PROBE COVER</td> <td>1</td> <td>PZ</td> </tr> <tr> <td>VM1465A1</td> <td>CT BT TEMPERATUR E PROBE COVER</td> <td>1</td> <td>PZ</td> </tr> <tr> <td>VM2052A0</td> <td>LM CORE PROBE COVE</td> <td>1</td> <td>PZ</td> </tr> </tbody> </table>	Code	Description	Qty	UOM	GN1120A0	TEMPERATUR E PROBE NTC SEAL	1	PZ	GN1120A1		1	PZ	GN1285A0	NTC TEMPERATUR E PROBE SEALING	1	PZ	SL1045A0	S57 BLACK SILICONE - 80ML CARTRIDGE	1	PZ	TR1105A4		1	PZ	VI1220A1	4,2X12 TCB SELF-TAPPIN G SCREW	2	PZ	VM1464A1	CT BT TEMPERATUR E PROBE COVER	1	PZ	VM1465A1	CT BT TEMPERATUR E PROBE COVER	1	PZ	VM2052A0	LM CORE PROBE COVE	1	PZ
Code	Description	Qty	UOM																																										
GN1120A0	TEMPERATUR E PROBE NTC SEAL	1	PZ																																										
GN1120A1		1	PZ																																										
GN1285A0	NTC TEMPERATUR E PROBE SEALING	1	PZ																																										
SL1045A0	S57 BLACK SILICONE - 80ML CARTRIDGE	1	PZ																																										
TR1105A4		1	PZ																																										
VI1220A1	4,2X12 TCB SELF-TAPPIN G SCREW	2	PZ																																										
VM1464A1	CT BT TEMPERATUR E PROBE COVER	1	PZ																																										
VM1465A1	CT BT TEMPERATUR E PROBE COVER	1	PZ																																										
VM2052A0	LM CORE PROBE COVE	1	PZ																																										
RC1170A	STAINLESS STEEL NUT M14 H=8 CH=22		KRC1170A	M14 H8 CH22 NUT - 10 PCS. KIT	<table border="1"> <thead> <tr> <th>Code</th> <th>Description</th> <th>Qty</th> <th>UOM</th> </tr> </thead> <tbody> <tr> <td>RC1170A1</td> <td>STAINLESS STEEL NUT M14 H=8 CH=2</td> <td>10</td> <td>PZ</td> </tr> <tr> <td>VM1224A0</td> <td></td> <td>0.200</td> <td>M</td> </tr> </tbody> </table>	Code	Description	Qty	UOM	RC1170A1	STAINLESS STEEL NUT M14 H=8 CH=2	10	PZ	VM1224A0		0.200	M																												
Code	Description	Qty	UOM																																										
RC1170A1	STAINLESS STEEL NUT M14 H=8 CH=2	10	PZ																																										
VM1224A0		0.200	M																																										
VM2331A	FAN GUARD-TRAYS HOLDER PIN		KVM2331A	KIT FAN GUARD-TRAYS HOLDER PIN	<table border="1"> <thead> <tr> <th>Code</th> <th>Description</th> <th>Qty</th> <th>UOM</th> </tr> </thead> <tbody> <tr> <td>VM1224A0</td> <td></td> <td>0.200</td> <td>M</td> </tr> <tr> <td>VM2331A0</td> <td>FAN GUARD-TRAY S HOLDER PIN</td> <td>4</td> <td>PZ</td> </tr> </tbody> </table>	Code	Description	Qty	UOM	VM1224A0		0.200	M	VM2331A0	FAN GUARD-TRAY S HOLDER PIN	4	PZ																												
Code	Description	Qty	UOM																																										
VM1224A0		0.200	M																																										
VM2331A0	FAN GUARD-TRAY S HOLDER PIN	4	PZ																																										



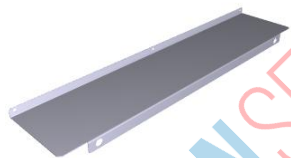
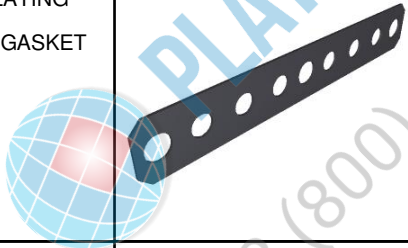

COMPONENT			SPARE PART																						
Code	Description	Image	Code	Description	Components list																				
0H7875A	MUFFLE SUPPORT BRACKET SHOP.PR		0H7875A0	MUFFLE SUPPORT BRACKET SHOP.PR																					
EL1250A	WATER SOLENOID VALVE 1-WAY RED		KEL1250A	1 WAY SOLENOID VALVE KIT J.G.D8 D1	<table border="1"> <thead> <tr> <th>Code</th> <th>Description</th> <th>Qty</th> <th>UOM</th> </tr> </thead> <tbody> <tr> <td>EL1250A0</td> <td>WATER SOLENOID VALVE 1-WAY RED</td> <td>1</td> <td>PZ</td> </tr> <tr> <td>VM1224A0</td> <td></td> <td>0.250</td> <td>M</td> </tr> </tbody> </table>	Code	Description	Qty	UOM	EL1250A0	WATER SOLENOID VALVE 1-WAY RED	1	PZ	VM1224A0		0.250	M								
Code	Description	Qty	UOM																						
EL1250A0	WATER SOLENOID VALVE 1-WAY RED	1	PZ																						
VM1224A0		0.250	M																						
TB1574A	FUME CHIMNEY D30 SHOP PRO		TB1574A0	FUME CHIMNEY D30 SHOP PRO																					
0H3020A	MOTOR SHAFT SEALING DISC		0H3020A1	MOTOR SHAFT SEALING DISC																					
MT1012A	330W 230V MOTOR		KMT1012A	MIND.MAPS 330W 230V MOTOR KIT	<table border="1"> <thead> <tr> <th>Code</th> <th>Description</th> <th>Qty</th> <th>UOM</th> </tr> </thead> <tbody> <tr> <td>0H4305A1</td> <td>ST. STEEL MOTOR SHAFT SEALING DISC</td> <td>1</td> <td>PZ</td> </tr> <tr> <td>GN1140A2</td> <td>MOTOR HOLDER GASKET</td> <td>1</td> <td>PZ</td> </tr> <tr> <td>GN1140A3</td> <td>MOLDED MOTOR HOLDER GASKET</td> <td>1</td> <td>PZ</td> </tr> <tr> <td>MT1012A0</td> <td>330W 230V MOTOR</td> <td>1</td> <td>PZ</td> </tr> </tbody> </table>	Code	Description	Qty	UOM	0H4305A1	ST. STEEL MOTOR SHAFT SEALING DISC	1	PZ	GN1140A2	MOTOR HOLDER GASKET	1	PZ	GN1140A3	MOLDED MOTOR HOLDER GASKET	1	PZ	MT1012A0	330W 230V MOTOR	1	PZ
Code	Description	Qty	UOM																						
0H4305A1	ST. STEEL MOTOR SHAFT SEALING DISC	1	PZ																						
GN1140A2	MOTOR HOLDER GASKET	1	PZ																						
GN1140A3	MOLDED MOTOR HOLDER GASKET	1	PZ																						
MT1012A0	330W 230V MOTOR	1	PZ																						

COMPONENT			SPARE PART																																		
Code	Description	Image	Code	Description	Components list																																
MT1012A	330W 230V MOTOR		KMT1012A	MIND.MAPS 330W 230V MOTOR KIT	<table border="1"> <thead> <tr> <th>Code</th> <th>Description</th> <th>Qty</th> <th>UOM</th> </tr> </thead> <tbody> <tr> <td>VE1550A0</td> <td>5X3 MM NEODYMIUM MAGNET</td> <td>1</td> <td>PZ</td> </tr> <tr> <td>VI1077A1</td> <td>SCREW M6X12 TE INOX</td> <td>1</td> <td>PZ</td> </tr> <tr> <td>VI1521A0</td> <td>STAINLESS STEEL WASHER D=6 6592</td> <td>1</td> <td>PZ</td> </tr> <tr> <td>VI1966A0</td> <td>M4X14 FLATHEAD SCREW</td> <td>1</td> <td>PZ</td> </tr> <tr> <td>VM1635A0</td> <td>MAGNET HOLDING DIS</td> <td>1</td> <td>PZ</td> </tr> <tr> <td>VM1794A0</td> <td>250X4.8 PA66 BLACK CLAMP</td> <td>4</td> <td>PZ</td> </tr> <tr> <td>VM2103A0</td> <td>CLAMP LOCK</td> <td>4</td> <td>PZ</td> </tr> </tbody> </table>	Code	Description	Qty	UOM	VE1550A0	5X3 MM NEODYMIUM MAGNET	1	PZ	VI1077A1	SCREW M6X12 TE INOX	1	PZ	VI1521A0	STAINLESS STEEL WASHER D=6 6592	1	PZ	VI1966A0	M4X14 FLATHEAD SCREW	1	PZ	VM1635A0	MAGNET HOLDING DIS	1	PZ	VM1794A0	250X4.8 PA66 BLACK CLAMP	4	PZ	VM2103A0	CLAMP LOCK	4	PZ
Code	Description	Qty	UOM																																		
VE1550A0	5X3 MM NEODYMIUM MAGNET	1	PZ																																		
VI1077A1	SCREW M6X12 TE INOX	1	PZ																																		
VI1521A0	STAINLESS STEEL WASHER D=6 6592	1	PZ																																		
VI1966A0	M4X14 FLATHEAD SCREW	1	PZ																																		
VM1635A0	MAGNET HOLDING DIS	1	PZ																																		
VM1794A0	250X4.8 PA66 BLACK CLAMP	4	PZ																																		
VM2103A0	CLAMP LOCK	4	PZ																																		
GN1547A	SHAFT GASKET D11.8		GN1547A1	SHAFT GASKET D11.8																																	
VN1181A			KVN1181A	D196 H81 39 BLADES FAN+SCREW M6 KIT	<table border="1"> <thead> <tr> <th>Code</th> <th>Description</th> <th>Qty</th> <th>UOM</th> </tr> </thead> <tbody> <tr> <td>VI1077A1</td> <td>SCREW M6X12 TE INOX</td> <td>1</td> <td>PZ</td> </tr> <tr> <td>VI1521A0</td> <td>STAINLESS STEEL WASHER D=6 6592</td> <td>1</td> <td>PZ</td> </tr> <tr> <td>VN1181A0</td> <td></td> <td>1</td> <td>PZ</td> </tr> <tr> <td>VN1181A0</td> <td></td> <td>1</td> <td>PZ</td> </tr> </tbody> </table>	Code	Description	Qty	UOM	VI1077A1	SCREW M6X12 TE INOX	1	PZ	VI1521A0	STAINLESS STEEL WASHER D=6 6592	1	PZ	VN1181A0		1	PZ	VN1181A0		1	PZ												
Code	Description	Qty	UOM																																		
VI1077A1	SCREW M6X12 TE INOX	1	PZ																																		
VI1521A0	STAINLESS STEEL WASHER D=6 6592	1	PZ																																		
VN1181A0		1	PZ																																		
VN1181A0		1	PZ																																		
0H7170A	MM MOTOR GLASS WOOL PLATE		0H7170A0	MM MOTOR GLASS WOOL PLATE																																	

COMPONENT			SPARE PART																														
Code	Description	Image	Code	Description	Components list																												
TB1638A	ELE-VIT-CAM SP WELDED EXT HUMIDITY PIPE		TB1638A0	ELE-VIT-CAM SP WELDED EXT HUMIDITY PIPE																													
OG1659A	VIT-CAM SP FAN GUARD SPACER		OG1659A0	VIT-CAM SP FAN GUARD SPACER																													
GN1085A	141X24 HEATING ELEMENT GASKET		KG1085A	HEATING ELEMENT GASKET KIT	<table border="1"> <thead> <tr> <th>Code</th> <th>Description</th> <th>Qty</th> <th>UOM</th> </tr> </thead> <tbody> <tr> <td>GN1085A2</td> <td>141X24 HEATING ELEMENT GASKET</td> <td>1</td> <td>PZ</td> </tr> <tr> <td>VM1224A0</td> <td></td> <td>0.200</td> <td>M</td> </tr> </tbody> </table>	Code	Description	Qty	UOM	GN1085A2	141X24 HEATING ELEMENT GASKET	1	PZ	VM1224A0		0.200	M																
Code	Description	Qty	UOM																														
GN1085A2	141X24 HEATING ELEMENT GASKET	1	PZ																														
VM1224A0		0.200	M																														
RS1286A			KRS1286A	6TURN HEAT ELEM 4900W 230V+400W 190V KIT	<table border="1"> <thead> <tr> <th>Code</th> <th>Description</th> <th>Qty</th> <th>UOM</th> </tr> </thead> <tbody> <tr> <td>GN1086A0</td> <td>ELEMENT SEALING</td> <td>1</td> <td>PZ</td> </tr> <tr> <td>RS1286A0</td> <td></td> <td>1</td> <td>PZ</td> </tr> <tr> <td>SL1045A0</td> <td>S57 BLACK SILICONE - 80ML CARTRIDGE</td> <td>1</td> <td>PZ</td> </tr> <tr> <td>VH1220A1</td> <td>4,2X12 TCB SELF-TAPPIN G SCREW</td> <td>1</td> <td>PZ</td> </tr> <tr> <td>VM1794A0</td> <td>250X4.8 PA66 BLACK CLAMP</td> <td>2</td> <td>PZ</td> </tr> <tr> <td>VM2103A0</td> <td>CLAMP LOCK</td> <td>2</td> <td>PZ</td> </tr> </tbody> </table>	Code	Description	Qty	UOM	GN1086A0	ELEMENT SEALING	1	PZ	RS1286A0		1	PZ	SL1045A0	S57 BLACK SILICONE - 80ML CARTRIDGE	1	PZ	VH1220A1	4,2X12 TCB SELF-TAPPIN G SCREW	1	PZ	VM1794A0	250X4.8 PA66 BLACK CLAMP	2	PZ	VM2103A0	CLAMP LOCK	2	PZ
Code	Description	Qty	UOM																														
GN1086A0	ELEMENT SEALING	1	PZ																														
RS1286A0		1	PZ																														
SL1045A0	S57 BLACK SILICONE - 80ML CARTRIDGE	1	PZ																														
VH1220A1	4,2X12 TCB SELF-TAPPIN G SCREW	1	PZ																														
VM1794A0	250X4.8 PA66 BLACK CLAMP	2	PZ																														
VM2103A0	CLAMP LOCK	2	PZ																														
OG1656A	CAMILLA SHOP PRO FAN GUARD		OG1656A0	CAMILLA SHOP PRO FAN GUARD																													





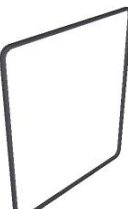

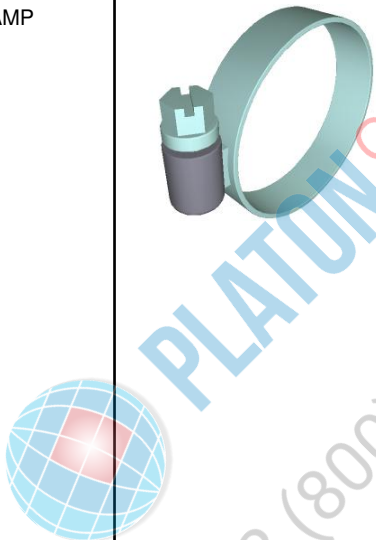
COMPONENT			SPARE PART														
Code	Description	Image	Code	Description	Components list												
VM1820A	LATERAL SUPPORTS M6 FIXING BOLT		KVM1820A	THUMB SCREW 10PCS KIT	<table border="1"> <thead> <tr> <th>Code</th> <th>Description</th> <th>Qty</th> <th>UOM</th> </tr> </thead> <tbody> <tr> <td>VM1224A0</td> <td></td> <td>0.200</td> <td>M</td> </tr> <tr> <td>VM1820A0</td> <td>LATERAL SUPPORTS M6 FIXING BOLT</td> <td>10</td> <td>PZ</td> </tr> </tbody> </table>	Code	Description	Qty	UOM	VM1224A0		0.200	M	VM1820A0	LATERAL SUPPORTS M6 FIXING BOLT	10	PZ
Code	Description	Qty	UOM														
VM1224A0		0.200	M														
VM1820A0	LATERAL SUPPORTS M6 FIXING BOLT	10	PZ														
VM2331A	FAN GUARD-TRAYS HOLDER PIN		KVM2331A	KIT FAN GUARD-TRAYS HOLDER PIN	<table border="1"> <thead> <tr> <th>Code</th> <th>Description</th> <th>Qty</th> <th>UOM</th> </tr> </thead> <tbody> <tr> <td>VM1224A0</td> <td></td> <td>0.200</td> <td>M</td> </tr> <tr> <td>VM2331A0</td> <td>FAN GUARD-TRAYS HOLDER PIN</td> <td>4</td> <td>PZ</td> </tr> </tbody> </table>	Code	Description	Qty	UOM	VM1224A0		0.200	M	VM2331A0	FAN GUARD-TRAYS HOLDER PIN	4	PZ
Code	Description	Qty	UOM														
VM1224A0		0.200	M														
VM2331A0	FAN GUARD-TRAYS HOLDER PIN	4	PZ														
GRL1503A			GRL1503A0														
GRL1504A			GRL1504A0														
GN1599A			KGN1599A	BL SHOP.PRO CAMILLA DOOR GASKET KIT	<table border="1"> <thead> <tr> <th>Code</th> <th>Description</th> <th>Qty</th> <th>UOM</th> </tr> </thead> <tbody> <tr> <td>GN1110A2</td> <td>LINE MISS/XVC105-055/XK/XL DOOR GASKE</td> <td>2.920</td> <td>M</td> </tr> <tr> <td>VM1224A0</td> <td></td> <td>0.450</td> <td>M</td> </tr> </tbody> </table>	Code	Description	Qty	UOM	GN1110A2	LINE MISS/XVC105-055/XK/XL DOOR GASKE	2.920	M	VM1224A0		0.450	M
Code	Description	Qty	UOM														
GN1110A2	LINE MISS/XVC105-055/XK/XL DOOR GASKE	2.920	M														
VM1224A0		0.450	M														

COMPONENT			SPARE PART																																																														
Code	Description	Image	Code	Description	Components list																																																												
TB1583A	CAMILLA SHOP PRO INTERNAL HUMIDITY PIPE		TB1583A0	CAMILLA SHOP PRO INTERNAL HUMIDITY PIPE																																																													
RC1378A	HOSE CLAMP		KVE1135A	SERIES 5/5E VENTURI KIT	<table border="1"> <thead> <tr> <th>Code</th> <th>Description</th> <th>Qty</th> <th>UOM</th> </tr> </thead> <tbody> <tr> <td>GN1556A0</td> <td>MM VENTURI SEAL</td> <td>1</td> <td>PZ</td> </tr> <tr> <td>RC1378A0</td> <td>HOSE CLAMP</td> <td>2</td> <td>PZ</td> </tr> <tr> <td>TB1520A0</td> <td>INT. Ø=38 TH=4 DRAIN BLACK RUBBER PIPE</td> <td>0.050</td> <td>M</td> </tr> <tr> <td>VE1135A0</td> <td>220 V 50/60 HZ VENTURI ACTUATOR</td> <td>1</td> <td>PZ</td> </tr> <tr> <td>VI1032A0</td> <td>SCREW M4X16 TCB+ INOX</td> <td>1</td> <td>PZ</td> </tr> <tr> <td>VI1511A0</td> <td>STAINLESS STEEL WASHER 4.2X12X1</td> <td>2</td> <td>PZ</td> </tr> <tr> <td>VI1850A0</td> <td>M4X6 NICKEL PLATED FIXING SCREW</td> <td>2</td> <td>PZ</td> </tr> <tr> <td>VI1865A0</td> <td>5X10 TCB+ SELF-THREADI NG SCREW</td> <td>3</td> <td>PZ</td> </tr> <tr> <td>VI1965A0</td> <td></td> <td>2</td> <td>PZ</td> </tr> <tr> <td>VM1224A0</td> <td></td> <td>0.250</td> <td>M</td> </tr> <tr> <td>VM1565B0</td> <td>VENTURI LOWER COIL SUPPORT</td> <td>1</td> <td>PZ</td> </tr> <tr> <td>VM1566A0</td> <td>VENTURI UPPER COIL SUPPORT</td> <td>1</td> <td>PZ</td> </tr> <tr> <td>VM1567A0</td> <td>VENTURI LOWER BUSHING</td> <td>1</td> <td>PZ</td> </tr> <tr> <td>VM1568A0</td> <td>VENTURI PLATE SPACE</td> <td>1</td> <td>PZ</td> </tr> </tbody> </table>	Code	Description	Qty	UOM	GN1556A0	MM VENTURI SEAL	1	PZ	RC1378A0	HOSE CLAMP	2	PZ	TB1520A0	INT. Ø=38 TH=4 DRAIN BLACK RUBBER PIPE	0.050	M	VE1135A0	220 V 50/60 HZ VENTURI ACTUATOR	1	PZ	VI1032A0	SCREW M4X16 TCB+ INOX	1	PZ	VI1511A0	STAINLESS STEEL WASHER 4.2X12X1	2	PZ	VI1850A0	M4X6 NICKEL PLATED FIXING SCREW	2	PZ	VI1865A0	5X10 TCB+ SELF-THREADI NG SCREW	3	PZ	VI1965A0		2	PZ	VM1224A0		0.250	M	VM1565B0	VENTURI LOWER COIL SUPPORT	1	PZ	VM1566A0	VENTURI UPPER COIL SUPPORT	1	PZ	VM1567A0	VENTURI LOWER BUSHING	1	PZ	VM1568A0	VENTURI PLATE SPACE	1	PZ
Code	Description	Qty	UOM																																																														
GN1556A0	MM VENTURI SEAL	1	PZ																																																														
RC1378A0	HOSE CLAMP	2	PZ																																																														
TB1520A0	INT. Ø=38 TH=4 DRAIN BLACK RUBBER PIPE	0.050	M																																																														
VE1135A0	220 V 50/60 HZ VENTURI ACTUATOR	1	PZ																																																														
VI1032A0	SCREW M4X16 TCB+ INOX	1	PZ																																																														
VI1511A0	STAINLESS STEEL WASHER 4.2X12X1	2	PZ																																																														
VI1850A0	M4X6 NICKEL PLATED FIXING SCREW	2	PZ																																																														
VI1865A0	5X10 TCB+ SELF-THREADI NG SCREW	3	PZ																																																														
VI1965A0		2	PZ																																																														
VM1224A0		0.250	M																																																														
VM1565B0	VENTURI LOWER COIL SUPPORT	1	PZ																																																														
VM1566A0	VENTURI UPPER COIL SUPPORT	1	PZ																																																														
VM1567A0	VENTURI LOWER BUSHING	1	PZ																																																														
VM1568A0	VENTURI PLATE SPACE	1	PZ																																																														

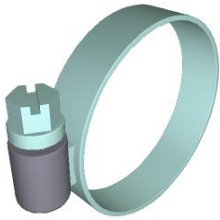

COMPONENT			SPARE PART																																																														
Code	Description	Image	Code	Description	Components list																																																												
RC1378A	HOSE CLAMP		KVE1135A	SERIES 5/5E VENTURI KIT	<table border="1"> <thead> <tr> <th>Code</th> <th>Description</th> <th>Qty</th> <th>UOM</th> </tr> </thead> <tbody> <tr> <td>GN1556A0</td> <td>MM VENTURI SEAL</td> <td>1</td> <td>PZ</td> </tr> <tr> <td>RC1378A0</td> <td>HOSE CLAMP</td> <td>2</td> <td>PZ</td> </tr> <tr> <td>TB1520A0</td> <td>INT. Ø=38 TH=4 DRAIN BLACK RUBBER PIPE</td> <td>0.050</td> <td>M</td> </tr> <tr> <td>VE1135A0</td> <td>220 V 50/60 HZ VENTURI ACTUATOR</td> <td>1</td> <td>PZ</td> </tr> <tr> <td>VI1032A0</td> <td>SCREW M4X16 TCB+ INOX</td> <td>1</td> <td>PZ</td> </tr> <tr> <td>VI1511A0</td> <td>STAINLESS STEEL WASHER 4.2X12X1</td> <td>2</td> <td>PZ</td> </tr> <tr> <td>VI1850A0</td> <td>M4X6 NICKEL PLATED FIXING SCRE</td> <td>2</td> <td>PZ</td> </tr> <tr> <td>VI1865A0</td> <td>5X10 TCB+ SELF-THREADI NG SCREW</td> <td>3</td> <td>PZ</td> </tr> <tr> <td>VI1965A0</td> <td></td> <td>2</td> <td>PZ</td> </tr> <tr> <td>VM1224A0</td> <td></td> <td>0.250</td> <td>M</td> </tr> <tr> <td>VM1565B0</td> <td>VENTURI LOWER COIL SUPPORT</td> <td>1</td> <td>PZ</td> </tr> <tr> <td>VM1566A0</td> <td>VENTURI UPPER COIL SUPPORT</td> <td>1</td> <td>PZ</td> </tr> <tr> <td>VM1567A0</td> <td>VENTURI LOWER BUSHING</td> <td>1</td> <td>PZ</td> </tr> <tr> <td>VM1568A0</td> <td>VENTURI PLATE SPACE</td> <td>1</td> <td>PZ</td> </tr> </tbody> </table>	Code	Description	Qty	UOM	GN1556A0	MM VENTURI SEAL	1	PZ	RC1378A0	HOSE CLAMP	2	PZ	TB1520A0	INT. Ø=38 TH=4 DRAIN BLACK RUBBER PIPE	0.050	M	VE1135A0	220 V 50/60 HZ VENTURI ACTUATOR	1	PZ	VI1032A0	SCREW M4X16 TCB+ INOX	1	PZ	VI1511A0	STAINLESS STEEL WASHER 4.2X12X1	2	PZ	VI1850A0	M4X6 NICKEL PLATED FIXING SCRE	2	PZ	VI1865A0	5X10 TCB+ SELF-THREADI NG SCREW	3	PZ	VI1965A0		2	PZ	VM1224A0		0.250	M	VM1565B0	VENTURI LOWER COIL SUPPORT	1	PZ	VM1566A0	VENTURI UPPER COIL SUPPORT	1	PZ	VM1567A0	VENTURI LOWER BUSHING	1	PZ	VM1568A0	VENTURI PLATE SPACE	1	PZ
Code	Description	Qty	UOM																																																														
GN1556A0	MM VENTURI SEAL	1	PZ																																																														
RC1378A0	HOSE CLAMP	2	PZ																																																														
TB1520A0	INT. Ø=38 TH=4 DRAIN BLACK RUBBER PIPE	0.050	M																																																														
VE1135A0	220 V 50/60 HZ VENTURI ACTUATOR	1	PZ																																																														
VI1032A0	SCREW M4X16 TCB+ INOX	1	PZ																																																														
VI1511A0	STAINLESS STEEL WASHER 4.2X12X1	2	PZ																																																														
VI1850A0	M4X6 NICKEL PLATED FIXING SCRE	2	PZ																																																														
VI1865A0	5X10 TCB+ SELF-THREADI NG SCREW	3	PZ																																																														
VI1965A0		2	PZ																																																														
VM1224A0		0.250	M																																																														
VM1565B0	VENTURI LOWER COIL SUPPORT	1	PZ																																																														
VM1566A0	VENTURI UPPER COIL SUPPORT	1	PZ																																																														
VM1567A0	VENTURI LOWER BUSHING	1	PZ																																																														
VM1568A0	VENTURI PLATE SPACE	1	PZ																																																														
VM1223A	RED PE-LD CONICAL CAP D.22.7-24.9		VM1223A0	RED PE-LD CONICAL CAP D.22.7-24.9																																																													

ASM3418A/0.D02 - External cover

FRONT









ASM3418A/0.D02 - External cover



REAR

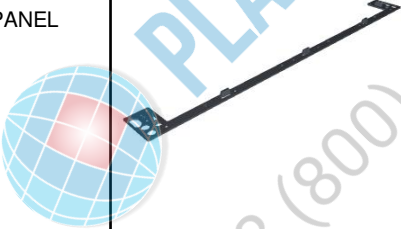

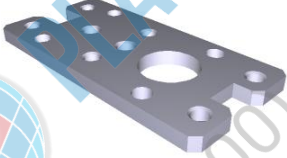

COMPONENT			SPARE PART																		
Code	Description	Image	Code	Description	Components list																
VM1750A	BRASS COMB CLAM		KVM1750A	COMB TERMINAL BLOCK KIT	<table border="1"> <thead> <tr> <th>Code</th> <th>Description</th> <th>Qty</th> <th>UOM</th> </tr> </thead> <tbody> <tr> <td>VM1224A0</td> <td></td> <td>0.150</td> <td>M</td> </tr> <tr> <td>VM1750A0</td> <td>BRASS COMB CLAMP</td> <td>1</td> <td>PZ</td> </tr> </tbody> </table>	Code	Description	Qty	UOM	VM1224A0		0.150	M	VM1750A0	BRASS COMB CLAMP	1	PZ				
Code	Description	Qty	UOM																		
VM1224A0		0.150	M																		
VM1750A0	BRASS COMB CLAMP	1	PZ																		
VM2249A	COOKING CHAMBER FRONT CORNER		KVM2249A	CHAMBER FRONT PROFILE CORNER KIT	<table border="1"> <thead> <tr> <th>Code</th> <th>Description</th> <th>Qty</th> <th>UOM</th> </tr> </thead> <tbody> <tr> <td>VM1224A0</td> <td></td> <td>0.150</td> <td>M</td> </tr> <tr> <td>VM2249A0</td> <td>COOKING CHAMBER FRONT CORNER</td> <td>1</td> <td>PZ</td> </tr> </tbody> </table>	Code	Description	Qty	UOM	VM1224A0		0.150	M	VM2249A0	COOKING CHAMBER FRONT CORNER	1	PZ				
Code	Description	Qty	UOM																		
VM1224A0		0.150	M																		
VM2249A0	COOKING CHAMBER FRONT CORNER	1	PZ																		
VM2502A	BAKERLUX SHOP.PRO CHIMNEY RING		KVM2502A	BAKERLUX SHOP.PRO CHIMNEY RING KIT	<table border="1"> <thead> <tr> <th>Code</th> <th>Description</th> <th>Qty</th> <th>UOM</th> </tr> </thead> <tbody> <tr> <td>VM1224A0</td> <td></td> <td>0.300</td> <td>M</td> </tr> <tr> <td>VM2502A0</td> <td>BAKERLUX SHOP.PRO CHIMNEY RIN</td> <td>1</td> <td>PZ</td> </tr> <tr> <td>VM2502A0</td> <td>BAKERLUX SHOP.PRO CHIMNEY RIN</td> <td>1</td> <td>PZ</td> </tr> </tbody> </table>	Code	Description	Qty	UOM	VM1224A0		0.300	M	VM2502A0	BAKERLUX SHOP.PRO CHIMNEY RIN	1	PZ	VM2502A0	BAKERLUX SHOP.PRO CHIMNEY RIN	1	PZ
Code	Description	Qty	UOM																		
VM1224A0		0.300	M																		
VM2502A0	BAKERLUX SHOP.PRO CHIMNEY RIN	1	PZ																		
VM2502A0	BAKERLUX SHOP.PRO CHIMNEY RIN	1	PZ																		
VM2481A	FRONT EXTERNAL COVER LEFT CAP S		KVM2481A	BL SP LEFT EXT COVER FRONT PANEL CAP KIT	<table border="1"> <thead> <tr> <th>Code</th> <th>Description</th> <th>Qty</th> <th>UOM</th> </tr> </thead> <tbody> <tr> <td>VM1224A0</td> <td></td> <td>0.150</td> <td>M</td> </tr> <tr> <td>VM2481A0</td> <td>FRONT EXTERNAL COVER LEFT CAP SP</td> <td>1</td> <td>PZ</td> </tr> <tr> <td>VM2481A0</td> <td>FRONT EXTERNAL COVER LEFT CAP SP</td> <td>1</td> <td>PZ</td> </tr> </tbody> </table>	Code	Description	Qty	UOM	VM1224A0		0.150	M	VM2481A0	FRONT EXTERNAL COVER LEFT CAP SP	1	PZ	VM2481A0	FRONT EXTERNAL COVER LEFT CAP SP	1	PZ
Code	Description	Qty	UOM																		
VM1224A0		0.150	M																		
VM2481A0	FRONT EXTERNAL COVER LEFT CAP SP	1	PZ																		
VM2481A0	FRONT EXTERNAL COVER LEFT CAP SP	1	PZ																		
VM2480A	FRONT EXTERNAL COVER RIGHT CAP SP		KVM2480A	BL SP RIGHT EXT COVER FRONT PANEL CAP	<table border="1"> <thead> <tr> <th>Code</th> <th>Description</th> <th>Qty</th> <th>UOM</th> </tr> </thead> <tbody> <tr> <td>VM1224A0</td> <td></td> <td>0.150</td> <td>M</td> </tr> <tr> <td>VM2480A0</td> <td>FRONT EXTERNAL COVER RIGHT CAP SP</td> <td>1</td> <td>PZ</td> </tr> <tr> <td>VM2480A0</td> <td>FRONT EXTERNAL COVER RIGHT CAP SP</td> <td>1</td> <td>PZ</td> </tr> </tbody> </table>	Code	Description	Qty	UOM	VM1224A0		0.150	M	VM2480A0	FRONT EXTERNAL COVER RIGHT CAP SP	1	PZ	VM2480A0	FRONT EXTERNAL COVER RIGHT CAP SP	1	PZ
Code	Description	Qty	UOM																		
VM1224A0		0.150	M																		
VM2480A0	FRONT EXTERNAL COVER RIGHT CAP SP	1	PZ																		
VM2480A0	FRONT EXTERNAL COVER RIGHT CAP SP	1	PZ																		

COMPONENT			SPARE PART																														
Code	Description	Image	Code	Description	Components list																												
VM1222A	CABLE LOCKS SP ACCESSORIES EL CONNECTION		VM1222A0	CABLE LOCKS SP ACCESSORIES EL CONNECTION																													
VM1631A			KVM1631A	CAP FOR INTERNAL GLASS 10 PCS KIT	<table border="1"> <thead> <tr> <th>Code</th> <th>Description</th> <th>Qty</th> <th>UOM</th> </tr> </thead> <tbody> <tr> <td>VM1224A0</td> <td></td> <td>0.200</td> <td>M</td> </tr> <tr> <td>VM1631A0</td> <td></td> <td>10</td> <td>PZ</td> </tr> </tbody> </table>	Code	Description	Qty	UOM	VM1224A0		0.200	M	VM1631A0		10	PZ																
Code	Description	Qty	UOM																														
VM1224A0		0.200	M																														
VM1631A0		10	PZ																														
VM2492A	BL SP 600X400 EXT BOTTOM PANEL GASKET		KVM2492A	SP 600X400 EXT BOT PANEL GASKET 2PC KIT	<table border="1"> <thead> <tr> <th>Code</th> <th>Description</th> <th>Qty</th> <th>UOM</th> </tr> </thead> <tbody> <tr> <td>VM1794A0</td> <td>250X4.8 PA66 BLACK CLAMP</td> <td>1</td> <td>PZ</td> </tr> <tr> <td>VM2103A0</td> <td>CLAMP LOCK</td> <td>1</td> <td>PZ</td> </tr> <tr> <td>VM2492A0</td> <td>BL SP 600X400 EXT BOTTOM PANEL GASKE</td> <td>2</td> <td>PZ</td> </tr> <tr> <td>VM2492A0</td> <td>BL SP 600X400 EXT BOTTOM PANEL GASKE</td> <td>2</td> <td>PZ</td> </tr> </tbody> </table>	Code	Description	Qty	UOM	VM1794A0	250X4.8 PA66 BLACK CLAMP	1	PZ	VM2103A0	CLAMP LOCK	1	PZ	VM2492A0	BL SP 600X400 EXT BOTTOM PANEL GASKE	2	PZ	VM2492A0	BL SP 600X400 EXT BOTTOM PANEL GASKE	2	PZ								
Code	Description	Qty	UOM																														
VM1794A0	250X4.8 PA66 BLACK CLAMP	1	PZ																														
VM2103A0	CLAMP LOCK	1	PZ																														
VM2492A0	BL SP 600X400 EXT BOTTOM PANEL GASKE	2	PZ																														
VM2492A0	BL SP 600X400 EXT BOTTOM PANEL GASKE	2	PZ																														
VM2493A	BL SP 600X400 EX LAT BOTTOM PANEL GASKET		KVM2493A	SP 600X400 BOT LAT PANEL GASKET 2PC KIT	<table border="1"> <thead> <tr> <th>Code</th> <th>Description</th> <th>Qty</th> <th>UOM</th> </tr> </thead> <tbody> <tr> <td>VM1631A0</td> <td></td> <td>4</td> <td>PZ</td> </tr> <tr> <td>VM1794A0</td> <td>250X4.8 PA66 BLACK CLAMP</td> <td>1</td> <td>PZ</td> </tr> <tr> <td>VM2103A0</td> <td>CLAMP LOCK</td> <td>1</td> <td>PZ</td> </tr> <tr> <td>VM2493A0</td> <td>BL SP 600X400 EX LAT BOTTOM PANEL GASKE</td> <td>2</td> <td>PZ</td> </tr> <tr> <td>VM2493A0</td> <td>BL SP 600X400 EX LAT BOTTOM PANEL GASKE</td> <td>2</td> <td>PZ</td> </tr> <tr> <td>VM2493A1</td> <td></td> <td>2</td> <td>PZ</td> </tr> </tbody> </table>	Code	Description	Qty	UOM	VM1631A0		4	PZ	VM1794A0	250X4.8 PA66 BLACK CLAMP	1	PZ	VM2103A0	CLAMP LOCK	1	PZ	VM2493A0	BL SP 600X400 EX LAT BOTTOM PANEL GASKE	2	PZ	VM2493A0	BL SP 600X400 EX LAT BOTTOM PANEL GASKE	2	PZ	VM2493A1		2	PZ
Code	Description	Qty	UOM																														
VM1631A0		4	PZ																														
VM1794A0	250X4.8 PA66 BLACK CLAMP	1	PZ																														
VM2103A0	CLAMP LOCK	1	PZ																														
VM2493A0	BL SP 600X400 EX LAT BOTTOM PANEL GASKE	2	PZ																														
VM2493A0	BL SP 600X400 EX LAT BOTTOM PANEL GASKE	2	PZ																														
VM2493A1		2	PZ																														
VM2290A	ELECTRIC LOCKING BLIND COVER		KVM2290A	BLSP BLIND LOCKING COVER KI	<table border="1"> <thead> <tr> <th>Code</th> <th>Description</th> <th>Qty</th> <th>UOM</th> </tr> </thead> <tbody> <tr> <td>V11024A0</td> <td>SCREW M4X12 TCB + INOX DIN 7985</td> <td>2</td> <td>PZ</td> </tr> <tr> <td>VM1224A0</td> <td></td> <td>0.300</td> <td>M</td> </tr> <tr> <td>VM2290A0</td> <td>ELECTRIC LOCKING BLIND COVER</td> <td>1</td> <td>PZ</td> </tr> </tbody> </table>	Code	Description	Qty	UOM	V11024A0	SCREW M4X12 TCB + INOX DIN 7985	2	PZ	VM1224A0		0.300	M	VM2290A0	ELECTRIC LOCKING BLIND COVER	1	PZ												
Code	Description	Qty	UOM																														
V11024A0	SCREW M4X12 TCB + INOX DIN 7985	2	PZ																														
VM1224A0		0.300	M																														
VM2290A0	ELECTRIC LOCKING BLIND COVER	1	PZ																														



COMPONENT			SPARE PART																		
Code	Description	Image	Code	Description	Components list																
VI1995A	M5X25 ST.STEEL SCREW		VI1995A0	M5X25 ST.STEEL SCREW																	
VM1240A	NYLON SUPPORT CAP		KVM1240A	4 PCS COUNTER BRACKET SUPPORT CAP KIT	<table border="1"> <thead> <tr> <th>Code</th> <th>Description</th> <th>Qty</th> <th>UOM</th> </tr> </thead> <tbody> <tr> <td>VM1224A0</td> <td></td> <td>0.200</td> <td>M</td> </tr> <tr> <td>VM1240A0</td> <td>NYLON SUPPORT CAP</td> <td>4</td> <td>PZ</td> </tr> </tbody> </table>	Code	Description	Qty	UOM	VM1224A0		0.200	M	VM1240A0	NYLON SUPPORT CAP	4	PZ				
Code	Description	Qty	UOM																		
VM1224A0		0.200	M																		
VM1240A0	NYLON SUPPORT CAP	4	PZ																		
0H7850A	SHOP PRO DOOR COUNTERBRACKET		0H7850A0	SHOP PRO DOOR COUNTERBRACKET																	
VI0515A	STAINLESS STEEL WASHER D=5 6592		VI0515A0	STAINLESS STEEL WASHER D=5 6592																	
VM2460A	BL SP LATERAL DOOR UPPER BRACKET COVER		KVM2460A	BL SP LAT DOOR UPP BRACKET COVER 2PC KIT	<table border="1"> <thead> <tr> <th>Code</th> <th>Description</th> <th>Qty</th> <th>UOM</th> </tr> </thead> <tbody> <tr> <td>VM1224A0</td> <td></td> <td>0.250</td> <td>M</td> </tr> <tr> <td>VM2460A0</td> <td>BL SP LATERAL DOOR UPPER BRACKET COVER</td> <td>1</td> <td>PZ</td> </tr> <tr> <td>VM2460A0</td> <td>BL SP LATERAL DOOR UPPER BRACKET COVER</td> <td>1</td> <td>PZ</td> </tr> </tbody> </table>	Code	Description	Qty	UOM	VM1224A0		0.250	M	VM2460A0	BL SP LATERAL DOOR UPPER BRACKET COVER	1	PZ	VM2460A0	BL SP LATERAL DOOR UPPER BRACKET COVER	1	PZ
Code	Description	Qty	UOM																		
VM1224A0		0.250	M																		
VM2460A0	BL SP LATERAL DOOR UPPER BRACKET COVER	1	PZ																		
VM2460A0	BL SP LATERAL DOOR UPPER BRACKET COVER	1	PZ																		

COMPONENT			SPARE PART																																		
Code	Description	Image	Code	Description	Components list																																
VM2459A	SP LATERAL DOOR UPPER BRACKET		KVM2459A	BL SP LATERAL DOOR UPPER BRACKET KIT	<table border="1"> <thead> <tr> <th>Code</th> <th>Description</th> <th>Qty</th> <th>UOM</th> </tr> </thead> <tbody> <tr> <td>VI0515A0</td> <td>STAINLESS STEEL WASHER D=5 6592</td> <td>4</td> <td>PZ</td> </tr> <tr> <td>VI1995A0</td> <td>M5X25 ST.STEEL SCREW</td> <td>4</td> <td>PZ</td> </tr> <tr> <td>VM1224A0</td> <td></td> <td>0.300</td> <td>M</td> </tr> <tr> <td>VM2459A1</td> <td>SP LATERAL DOOR UPPER BRACKET</td> <td>1</td> <td>PZ</td> </tr> <tr> <td>VM2459A1</td> <td>SP LATERAL DOOR UPPER BRACKET</td> <td>1</td> <td>PZ</td> </tr> <tr> <td>VM2460A0</td> <td>BL SP LATERAL DOOR UPPER BRACKET COVER</td> <td>1</td> <td>PZ</td> </tr> <tr> <td>VM2460A0</td> <td>BL SP LATERAL DOOR UPPER BRACKET COVER</td> <td>1</td> <td>PZ</td> </tr> </tbody> </table>	Code	Description	Qty	UOM	VI0515A0	STAINLESS STEEL WASHER D=5 6592	4	PZ	VI1995A0	M5X25 ST.STEEL SCREW	4	PZ	VM1224A0		0.300	M	VM2459A1	SP LATERAL DOOR UPPER BRACKET	1	PZ	VM2459A1	SP LATERAL DOOR UPPER BRACKET	1	PZ	VM2460A0	BL SP LATERAL DOOR UPPER BRACKET COVER	1	PZ	VM2460A0	BL SP LATERAL DOOR UPPER BRACKET COVER	1	PZ
Code	Description	Qty	UOM																																		
VI0515A0	STAINLESS STEEL WASHER D=5 6592	4	PZ																																		
VI1995A0	M5X25 ST.STEEL SCREW	4	PZ																																		
VM1224A0		0.300	M																																		
VM2459A1	SP LATERAL DOOR UPPER BRACKET	1	PZ																																		
VM2459A1	SP LATERAL DOOR UPPER BRACKET	1	PZ																																		
VM2460A0	BL SP LATERAL DOOR UPPER BRACKET COVER	1	PZ																																		
VM2460A0	BL SP LATERAL DOOR UPPER BRACKET COVER	1	PZ																																		
VI1995A	M5X25 ST.STEEL SCREW		VI1995A0	M5X25 ST.STEEL SCREW																																	
VM1240A	NYLON SUPPORT CAP		KVM1240A	4 PCS COUNTER BRACKET SUPPORT CAP KIT	<table border="1"> <thead> <tr> <th>Code</th> <th>Description</th> <th>Qty</th> <th>UOM</th> </tr> </thead> <tbody> <tr> <td>VM1224A0</td> <td></td> <td>0.200</td> <td>M</td> </tr> <tr> <td>VM1240A0</td> <td>NYLON SUPPORT CAP</td> <td>4</td> <td>PZ</td> </tr> </tbody> </table>	Code	Description	Qty	UOM	VM1224A0		0.200	M	VM1240A0	NYLON SUPPORT CAP	4	PZ																				
Code	Description	Qty	UOM																																		
VM1224A0		0.200	M																																		
VM1240A0	NYLON SUPPORT CAP	4	PZ																																		



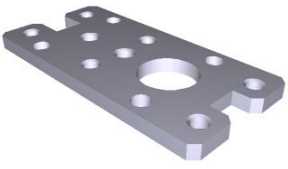
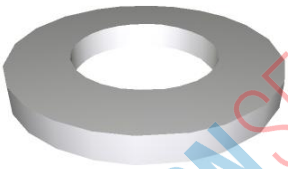
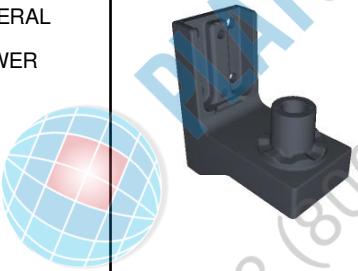

COMPONENT			SPARE PART																																		
Code	Description	Image	Code	Description	Components list																																
0H7850A	SHOP PRO DOOR COUNTERBRACKET		0H7850A0	SHOP PRO DOOR COUNTERBRACKET																																	
VI0515A	STAINLESS STEEL WASHER D=5 6592		VI0515A0	STAINLESS STEEL WASHER D=5 6592																																	
VM2457A	BL SP LATERAL DOOR LOWER BRACKET		KVM2457A	BL SP LATERAL DOOR LOWER BRACKET KIT	<table border="1"> <thead> <tr> <th>Code</th> <th>Description</th> <th>Qty</th> <th>UOM</th> </tr> </thead> <tbody> <tr> <td>VI0515A0</td> <td>STAINLESS STEEL WASHER D=5 6592</td> <td>2</td> <td>PZ</td> </tr> <tr> <td>VI1995A0</td> <td>M5X25 ST.STEEL SCREW</td> <td>2</td> <td>PZ</td> </tr> <tr> <td>VM1224A0</td> <td></td> <td>0.300</td> <td>M</td> </tr> <tr> <td>VM2457A0</td> <td>BL SP LATERAL DOOR LOWER BRACKET</td> <td>1</td> <td>PZ</td> </tr> <tr> <td>VM2457A0</td> <td>BL SP LATERAL DOOR LOWER BRACKET</td> <td>1</td> <td>PZ</td> </tr> <tr> <td>VM2458A0</td> <td>BL SP LATERAL DOOR LOW BRACKET COVER</td> <td>1</td> <td>PZ</td> </tr> <tr> <td>VM2458A0</td> <td>BL SP LATERAL DOOR LOW BRACKET COVER</td> <td>1</td> <td>PZ</td> </tr> </tbody> </table>	Code	Description	Qty	UOM	VI0515A0	STAINLESS STEEL WASHER D=5 6592	2	PZ	VI1995A0	M5X25 ST.STEEL SCREW	2	PZ	VM1224A0		0.300	M	VM2457A0	BL SP LATERAL DOOR LOWER BRACKET	1	PZ	VM2457A0	BL SP LATERAL DOOR LOWER BRACKET	1	PZ	VM2458A0	BL SP LATERAL DOOR LOW BRACKET COVER	1	PZ	VM2458A0	BL SP LATERAL DOOR LOW BRACKET COVER	1	PZ
Code	Description	Qty	UOM																																		
VI0515A0	STAINLESS STEEL WASHER D=5 6592	2	PZ																																		
VI1995A0	M5X25 ST.STEEL SCREW	2	PZ																																		
VM1224A0		0.300	M																																		
VM2457A0	BL SP LATERAL DOOR LOWER BRACKET	1	PZ																																		
VM2457A0	BL SP LATERAL DOOR LOWER BRACKET	1	PZ																																		
VM2458A0	BL SP LATERAL DOOR LOW BRACKET COVER	1	PZ																																		
VM2458A0	BL SP LATERAL DOOR LOW BRACKET COVER	1	PZ																																		







COMPONENT			SPARE PART																		
Code	Description	Image	Code	Description	Components list																
VM2458A	BL SP LATERAL DOOR LOW BRACKET COVER		KVM2458A	BL SP LAT DOOR LOW BRACKET COVER 2PC KIT	<table border="1"> <thead> <tr> <th>Code</th> <th>Description</th> <th>Qty</th> <th>UOM</th> </tr> </thead> <tbody> <tr> <td>VM1224A0</td> <td></td> <td>0.200</td> <td>M</td> </tr> <tr> <td>VM2458A0</td> <td>BL SP LATERAL DOOR LOW BRACKET COVER</td> <td>2</td> <td>PZ</td> </tr> <tr> <td>VM2458A0</td> <td>BL SP LATERAL DOOR LOW BRACKET COVER</td> <td>2</td> <td>PZ</td> </tr> </tbody> </table>	Code	Description	Qty	UOM	VM1224A0		0.200	M	VM2458A0	BL SP LATERAL DOOR LOW BRACKET COVER	2	PZ	VM2458A0	BL SP LATERAL DOOR LOW BRACKET COVER	2	PZ
Code	Description	Qty	UOM																		
VM1224A0		0.200	M																		
VM2458A0	BL SP LATERAL DOOR LOW BRACKET COVER	2	PZ																		
VM2458A0	BL SP LATERAL DOOR LOW BRACKET COVER	2	PZ																		
VM1240A	NYLON SUPPORT CAP		KVM1240A	4 PCS COUNTER BRACKET SUPPORT CAP KIT	<table border="1"> <thead> <tr> <th>Code</th> <th>Description</th> <th>Qty</th> <th>UOM</th> </tr> </thead> <tbody> <tr> <td>VM1224A0</td> <td></td> <td>0.200</td> <td>M</td> </tr> <tr> <td>VM1240A0</td> <td>NYLON SUPPORT CAP</td> <td>4</td> <td>PZ</td> </tr> </tbody> </table>	Code	Description	Qty	UOM	VM1224A0		0.200	M	VM1240A0	NYLON SUPPORT CAP	4	PZ				
Code	Description	Qty	UOM																		
VM1224A0		0.200	M																		
VM1240A0	NYLON SUPPORT CAP	4	PZ																		
VM1195A	HOLES BLANKING PLATE XVC204/304/504/704		VM1195A0	HOLES BLANKING PLATE XVC204/304/504/704																	
0H7850A	SHOP PRO DOOR COUNTERBRACKET		0H7850A0	SHOP PRO DOOR COUNTERBRACKET																	
VM2511A	SP FRONT PANEL HOLE PLATE COVER		KVM2511A	SP FRONT PANEL HOLE PLATE COVER 2PCS KIT	<table border="1"> <thead> <tr> <th>Code</th> <th>Description</th> <th>Qty</th> <th>UOM</th> </tr> </thead> <tbody> <tr> <td>VM1224A0</td> <td></td> <td>0.150</td> <td>M</td> </tr> <tr> <td>VM2511A0</td> <td>SP FRONT PANEL HOLE PLATE COVER</td> <td>2</td> <td>PZ</td> </tr> <tr> <td>VM2511A0</td> <td>SP FRONT PANEL HOLE PLATE COVER</td> <td>2</td> <td>PZ</td> </tr> </tbody> </table>	Code	Description	Qty	UOM	VM1224A0		0.150	M	VM2511A0	SP FRONT PANEL HOLE PLATE COVER	2	PZ	VM2511A0	SP FRONT PANEL HOLE PLATE COVER	2	PZ
Code	Description	Qty	UOM																		
VM1224A0		0.150	M																		
VM2511A0	SP FRONT PANEL HOLE PLATE COVER	2	PZ																		
VM2511A0	SP FRONT PANEL HOLE PLATE COVER	2	PZ																		



COMPONENT			SPARE PART														
Code	Description	Image	Code	Description	Components list												
0E1382A	SP800 EXTERNAL BOTTOM PANEL		0E1382A1	SP800 EXTERNAL BOTTOM PANEL													
0D2412A	SP800 INF FRONT PROFILE RIGHT-LEFT DOOR		0D2412A1	SP800 INF FRONT PROFILE RIGHT-LEFT DOOR													
0D2414A	SP800 COVER		0D2414A1	SP800 COVER													
VI1995A	M5X25 ST.STEEL SCREW		VI1995A0	M5X25 ST.STEEL SCREW													
VM1240A	NYLON SUPPORT CAP		KVM1240A	4 PCS COUNTER BRACKET SUPPORT CAP KIT	<table border="1"> <thead> <tr> <th>Code</th> <th>Description</th> <th>Qty</th> <th>UOM</th> </tr> </thead> <tbody> <tr> <td>VM1224A0</td> <td></td> <td>0.200</td> <td>M</td> </tr> <tr> <td>VM1240A0</td> <td>NYLON SUPPORT CAP</td> <td>4</td> <td>PZ</td> </tr> </tbody> </table>	Code	Description	Qty	UOM	VM1224A0		0.200	M	VM1240A0	NYLON SUPPORT CAP	4	PZ
Code	Description	Qty	UOM														
VM1224A0		0.200	M														
VM1240A0	NYLON SUPPORT CAP	4	PZ														

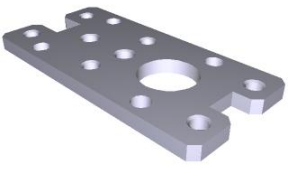
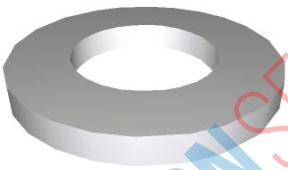



COMPONENT			SPARE PART																										
Code	Description	Image	Code	Description	Components list																								
0H7850A	SHOP PRO DOOR COUNTERBRACKET		0H7850A0	SHOP PRO DOOR COUNTERBRACKET																									
VI0515A	STAINLESS STEEL WASHER D=5 6592		VI0515A0	STAINLESS STEEL WASHER D=5 6592																									
VM2458A	BL SP LATERAL DOOR LOW BRACKET COVER		KVM2458A	BL SP LAT DOOR LOW BRACKET COVER 2PC KIT	<table border="1"> <thead> <tr> <th>Code</th> <th>Description</th> <th>Qty</th> <th>UOM</th> </tr> </thead> <tbody> <tr> <td>VM1224A0</td> <td></td> <td>0.200</td> <td>M</td> </tr> <tr> <td>VM2458A0</td> <td>BL SP LATERAL DOOR LOW BRACKET COVER</td> <td>2</td> <td>PZ</td> </tr> <tr> <td>VM2458A0</td> <td>BL SP LATERAL DOOR LOW BRACKET COVER</td> <td>2</td> <td>PZ</td> </tr> </tbody> </table>	Code	Description	Qty	UOM	VM1224A0		0.200	M	VM2458A0	BL SP LATERAL DOOR LOW BRACKET COVER	2	PZ	VM2458A0	BL SP LATERAL DOOR LOW BRACKET COVER	2	PZ								
Code	Description	Qty	UOM																										
VM1224A0		0.200	M																										
VM2458A0	BL SP LATERAL DOOR LOW BRACKET COVER	2	PZ																										
VM2458A0	BL SP LATERAL DOOR LOW BRACKET COVER	2	PZ																										
VM2469A	BL SP LATERAL DOOR HOLDER BRACKET		KVM2469A	BL SP LATERAL DOOR HOLDER BRACKET KIT	<table border="1"> <thead> <tr> <th>Code</th> <th>Description</th> <th>Qty</th> <th>UOM</th> </tr> </thead> <tbody> <tr> <td>VI0515A0</td> <td>STAINLESS STEEL WASHER D=5 6592</td> <td>2</td> <td>PZ</td> </tr> <tr> <td>VI1995A0</td> <td>M5X25 ST.STEEL SCREW</td> <td>2</td> <td>PZ</td> </tr> <tr> <td>VM1224A0</td> <td></td> <td>0.200</td> <td>M</td> </tr> <tr> <td>VM2458A0</td> <td>BL SP LATERAL DOOR LOW BRACKET COVER</td> <td>1</td> <td>PZ</td> </tr> <tr> <td>VM2458A0</td> <td>BL SP LATERAL DOOR LOW BRACKET COVER</td> <td>1</td> <td>PZ</td> </tr> </tbody> </table>	Code	Description	Qty	UOM	VI0515A0	STAINLESS STEEL WASHER D=5 6592	2	PZ	VI1995A0	M5X25 ST.STEEL SCREW	2	PZ	VM1224A0		0.200	M	VM2458A0	BL SP LATERAL DOOR LOW BRACKET COVER	1	PZ	VM2458A0	BL SP LATERAL DOOR LOW BRACKET COVER	1	PZ
Code	Description	Qty	UOM																										
VI0515A0	STAINLESS STEEL WASHER D=5 6592	2	PZ																										
VI1995A0	M5X25 ST.STEEL SCREW	2	PZ																										
VM1224A0		0.200	M																										
VM2458A0	BL SP LATERAL DOOR LOW BRACKET COVER	1	PZ																										
VM2458A0	BL SP LATERAL DOOR LOW BRACKET COVER	1	PZ																										



COMPONENT			SPARE PART														
Code	Description	Image	Code	Description	Components list												
VM2469A	BL SP LATERAL DOOR HOLDER BRACKET		KVM2469A	BL SP LATERAL DOOR HOLDER BRACKET KIT	<table border="1"> <thead> <tr> <th>Code</th> <th>Description</th> <th>Qty</th> <th>UOM</th> </tr> </thead> <tbody> <tr> <td>VM2469A0</td> <td>BL SP LATERAL DOOR HOLDER BRACKET</td> <td>1</td> <td>PZ</td> </tr> <tr> <td>VM2469A0</td> <td>BL SP LATERAL DOOR HOLDER BRACKET</td> <td>1</td> <td>PZ</td> </tr> </tbody> </table>	Code	Description	Qty	UOM	VM2469A0	BL SP LATERAL DOOR HOLDER BRACKET	1	PZ	VM2469A0	BL SP LATERAL DOOR HOLDER BRACKET	1	PZ
Code	Description	Qty	UOM														
VM2469A0	BL SP LATERAL DOOR HOLDER BRACKET	1	PZ														
VM2469A0	BL SP LATERAL DOOR HOLDER BRACKET	1	PZ														
VM2579A	SP CAP WEDGE FOR TRANSPORT		VM2579A0	SP CAP WEDGE FOR TRANSPORT													
VN1175A	230V 50/60HZ 120X120 COOLING DOWN FAN		KVN1175A	120X120 230V 50/60HZ COOLING FAN KIT	<table border="1"> <thead> <tr> <th>Code</th> <th>Description</th> <th>Qty</th> <th>UOM</th> </tr> </thead> <tbody> <tr> <td>VN1175A0</td> <td>230V 50/60HZ 120X120 COOLING DOWN FAN</td> <td>1</td> <td>PZ</td> </tr> <tr> <td>VN1175A0</td> <td>230V 50/60HZ 120X120 COOLING DOWN FAN</td> <td>1</td> <td>PZ</td> </tr> </tbody> </table>	Code	Description	Qty	UOM	VN1175A0	230V 50/60HZ 120X120 COOLING DOWN FAN	1	PZ	VN1175A0	230V 50/60HZ 120X120 COOLING DOWN FAN	1	PZ
Code	Description	Qty	UOM														
VN1175A0	230V 50/60HZ 120X120 COOLING DOWN FAN	1	PZ														
VN1175A0	230V 50/60HZ 120X120 COOLING DOWN FAN	1	PZ														
VM2495A	SP COOLING FAN SUPPORT		KVM2495A	COOLING FAN SUPPORT KIT	<table border="1"> <thead> <tr> <th>Code</th> <th>Description</th> <th>Qty</th> <th>UOM</th> </tr> </thead> <tbody> <tr> <td>VI1220A1</td> <td>4,2X12 TCB SELF-TAPPING G.SCREW</td> <td>2</td> <td>PZ</td> </tr> <tr> <td>VM2495A0</td> <td>SP COOLING FAN SUPPORT</td> <td>1</td> <td>PZ</td> </tr> </tbody> </table>	Code	Description	Qty	UOM	VI1220A1	4,2X12 TCB SELF-TAPPING G.SCREW	2	PZ	VM2495A0	SP COOLING FAN SUPPORT	1	PZ
Code	Description	Qty	UOM														
VI1220A1	4,2X12 TCB SELF-TAPPING G.SCREW	2	PZ														
VM2495A0	SP COOLING FAN SUPPORT	1	PZ														
VE1295A	MK 16A 230V DOOR MICROSWITCH		KVE1295A	16A 230V DOOR MICROSWITCH KIT	<table border="1"> <thead> <tr> <th>Code</th> <th>Description</th> <th>Qty</th> <th>UOM</th> </tr> </thead> <tbody> <tr> <td>VE1295A0</td> <td>MK 16A 230V DOOR MICROSWITCH</td> <td>1</td> <td>PZ</td> </tr> <tr> <td>VM1224A0</td> <td></td> <td>0.300</td> <td>M</td> </tr> </tbody> </table>	Code	Description	Qty	UOM	VE1295A0	MK 16A 230V DOOR MICROSWITCH	1	PZ	VM1224A0		0.300	M
Code	Description	Qty	UOM														
VE1295A0	MK 16A 230V DOOR MICROSWITCH	1	PZ														
VM1224A0		0.300	M														

COMPONENT			SPARE PART																										
Code	Description	Image	Code	Description	Components list																								
CR1013A	SHOP PRO PUSH TO CLOSE COMPLETE LATCH		KCR1013A	BLSP LATCH PUSH TO CLOSE LOCK KIT	<table border="1"> <thead> <tr> <th>Code</th> <th>Description</th> <th>Qty</th> <th>UOM</th> </tr> </thead> <tbody> <tr> <td>CR1013A0</td> <td>SHOP PRO PUSH TO CLOSE COMPLETE LATCH</td> <td>1</td> <td>PZ</td> </tr> <tr> <td>CR1013A1</td> <td></td> <td>1</td> <td>PZ</td> </tr> <tr> <td>VI1014A0</td> <td>STAINLESS STEEL WASHER 4.5X9X0.8</td> <td>2</td> <td>PZ</td> </tr> <tr> <td>VI1024A0</td> <td>SCREW M4X12 TCB + INOX DIN 7985</td> <td>2</td> <td>PZ</td> </tr> <tr> <td>VM1224A0</td> <td></td> <td>0.200</td> <td>M</td> </tr> </tbody> </table>	Code	Description	Qty	UOM	CR1013A0	SHOP PRO PUSH TO CLOSE COMPLETE LATCH	1	PZ	CR1013A1		1	PZ	VI1014A0	STAINLESS STEEL WASHER 4.5X9X0.8	2	PZ	VI1024A0	SCREW M4X12 TCB + INOX DIN 7985	2	PZ	VM1224A0		0.200	M
Code	Description	Qty	UOM																										
CR1013A0	SHOP PRO PUSH TO CLOSE COMPLETE LATCH	1	PZ																										
CR1013A1		1	PZ																										
VI1014A0	STAINLESS STEEL WASHER 4.5X9X0.8	2	PZ																										
VI1024A0	SCREW M4X12 TCB + INOX DIN 7985	2	PZ																										
VM1224A0		0.200	M																										
VM2547A	SP PUSH TO CLOSE DOOR SPRING LATCH COVER		KVM2547A	BLSP PUSH-TO-CLOSE DOOR COVER LATCH KIT	<table border="1"> <thead> <tr> <th>Code</th> <th>Description</th> <th>Qty</th> <th>UOM</th> </tr> </thead> <tbody> <tr> <td>VI1014A0</td> <td>STAINLESS STEEL WASHER 4.5X9X0.8</td> <td>2</td> <td>PZ</td> </tr> <tr> <td>VI1024A0</td> <td>SCREW M4X12 TCB + INOX DIN 7985</td> <td>2</td> <td>PZ</td> </tr> <tr> <td>VM1224A0</td> <td></td> <td>0.350</td> <td>M</td> </tr> <tr> <td>VM2547A0</td> <td>SP PUSH TO CLOSE DOOR SPRING LATCH COVER</td> <td>1</td> <td>PZ</td> </tr> <tr> <td>VM2547A1</td> <td>BLSP PUSH-TO-CLOSE DOOR COVER LATCH</td> <td>1</td> <td>PZ</td> </tr> </tbody> </table>	Code	Description	Qty	UOM	VI1014A0	STAINLESS STEEL WASHER 4.5X9X0.8	2	PZ	VI1024A0	SCREW M4X12 TCB + INOX DIN 7985	2	PZ	VM1224A0		0.350	M	VM2547A0	SP PUSH TO CLOSE DOOR SPRING LATCH COVER	1	PZ	VM2547A1	BLSP PUSH-TO-CLOSE DOOR COVER LATCH	1	PZ
Code	Description	Qty	UOM																										
VI1014A0	STAINLESS STEEL WASHER 4.5X9X0.8	2	PZ																										
VI1024A0	SCREW M4X12 TCB + INOX DIN 7985	2	PZ																										
VM1224A0		0.350	M																										
VM2547A0	SP PUSH TO CLOSE DOOR SPRING LATCH COVER	1	PZ																										
VM2547A1	BLSP PUSH-TO-CLOSE DOOR COVER LATCH	1	PZ																										
VL1022B	D30 WATER DRAIN END KIT		KVL1022A	LINEMISSTOP WATER DRAIN END KIT	<table border="1"> <thead> <tr> <th>Code</th> <th>Description</th> <th>Qty</th> <th>UOM</th> </tr> </thead> <tbody> <tr> <td>VL1022A0</td> <td>LINEMISSTOP WATER DRAIN END</td> <td>1</td> <td>PZ</td> </tr> <tr> <td>VM1224A0</td> <td></td> <td>0.250</td> <td>M</td> </tr> </tbody> </table>	Code	Description	Qty	UOM	VL1022A0	LINEMISSTOP WATER DRAIN END	1	PZ	VM1224A0		0.250	M												
Code	Description	Qty	UOM																										
VL1022A0	LINEMISSTOP WATER DRAIN END	1	PZ																										
VM1224A0		0.250	M																										
0D2463A	CAMILLA SP PUSH TO CLOSE LEFT SID		0D2463A0	CAMILLA SP PUSH TO CLOSE LEFT SID																									



COMPONENT			SPARE PART		
Code	Description	Image	Code	Description	Components list
0D2464A	CAMILLA SP PUSH TO CLOSE RIGHT SIDE		0D2464A0	CAMILLA SP PUSH TO CLOSE RIGHT SIDE	
0F1546C	CAMILLA SHOP PRO BACK PANEL		0F1546C0	CAMILLA SHOP PRO BACK PANEL	



PLATON SERVICE  
 8 (800) 500-34-47  
 www.platonservice.com

ASM3435A/0.D01 - Door

FRONT



ASM3435A/0.D01 - Door

REAR





COMPONENT			SPARE PART																																																							
Code	Description	Image	Code	Description	Components list																																																					
VM2274A	GROOVED BUSHING		KVM2274A	GROOVED PIN BUSHING KIT	<table border="1"> <thead> <tr> <th>Code</th> <th>Description</th> <th>Qty</th> <th>UOM</th> </tr> </thead> <tbody> <tr> <td>VM1224A0</td> <td></td> <td>0.150</td> <td>M</td> </tr> <tr> <td>VM2274A0</td> <td>GROOVED BUSHING</td> <td>1</td> <td>PZ</td> </tr> </tbody> </table>	Code	Description	Qty	UOM	VM1224A0		0.150	M	VM2274A0	GROOVED BUSHING	1	PZ																																									
			Code	Description	Qty	UOM																																																				
VM1224A0		0.150	M																																																							
VM2274A0	GROOVED BUSHING	1	PZ																																																							
K0B1126AR	BAKERTOP MM RIGHT DOOR LOWER BEAM KIT	<table border="1"> <thead> <tr> <th>Code</th> <th>Description</th> <th>Qty</th> <th>UOM</th> </tr> </thead> <tbody> <tr> <td>0B1126A0</td> <td>DOOR LOWER FRAME SHAPE 860 MM</td> <td>1</td> <td>PZ</td> </tr> <tr> <td>0B1126A1</td> <td></td> <td>1</td> <td>PZ</td> </tr> <tr> <td>RC1200A0</td> <td>ED=4 WIRE D.=0.5 COMPRESSIO N SPRING</td> <td>2</td> <td>PZ</td> </tr> <tr> <td>VI1220A1</td> <td>4,2X12 TCB SELF-TAPPIN G SCREW</td> <td>1</td> <td>PZ</td> </tr> <tr> <td>VI1996A0</td> <td>M5X35 SCREW</td> <td>7</td> <td>PZ</td> </tr> <tr> <td>VM1794A0</td> <td>250X4.8 PA66 BLACK CLAMP</td> <td>2</td> <td>PZ</td> </tr> <tr> <td>VM2103A0</td> <td>CLAMP LOCK</td> <td>2</td> <td>PZ</td> </tr> <tr> <td>VM2259A1</td> <td>6 SERIES DOOR LOWER LEFT CAP</td> <td>1</td> <td>PZ</td> </tr> <tr> <td>VM2261A1</td> <td>6 SERIES DOOR LOWER RIGHT CAP</td> <td>1</td> <td>PZ</td> </tr> <tr> <td>VM2267A0</td> <td>INTERNAL GLASS LOCKING SYSTEM SLIDER</td> <td>1</td> <td>PZ</td> </tr> <tr> <td>VM2269A0</td> <td>INTERNAL GLASS LOCKING SYSTEM CAP</td> <td>1</td> <td>PZ</td> </tr> <tr> <td>VM2274A0</td> <td>GROOVED BUSHING</td> <td>1</td> <td>PZ</td> </tr> <tr> <td>VM2305A0</td> <td>6 SERIES DOOR CAP FIXING PAWL</td> <td>7</td> <td>PZ</td> </tr> </tbody> </table>	Code	Description	Qty	UOM	0B1126A0	DOOR LOWER FRAME SHAPE 860 MM	1	PZ	0B1126A1		1	PZ	RC1200A0	ED=4 WIRE D.=0.5 COMPRESSIO N SPRING	2	PZ	VI1220A1	4,2X12 TCB SELF-TAPPIN G SCREW	1	PZ	VI1996A0	M5X35 SCREW	7	PZ	VM1794A0	250X4.8 PA66 BLACK CLAMP	2	PZ	VM2103A0	CLAMP LOCK	2	PZ	VM2259A1	6 SERIES DOOR LOWER LEFT CAP	1	PZ	VM2261A1	6 SERIES DOOR LOWER RIGHT CAP	1	PZ	VM2267A0	INTERNAL GLASS LOCKING SYSTEM SLIDER	1	PZ	VM2269A0	INTERNAL GLASS LOCKING SYSTEM CAP	1	PZ	VM2274A0	GROOVED BUSHING	1	PZ	VM2305A0	6 SERIES DOOR CAP FIXING PAWL	7	PZ
Code	Description	Qty	UOM																																																							
0B1126A0	DOOR LOWER FRAME SHAPE 860 MM	1	PZ																																																							
0B1126A1		1	PZ																																																							
RC1200A0	ED=4 WIRE D.=0.5 COMPRESSIO N SPRING	2	PZ																																																							
VI1220A1	4,2X12 TCB SELF-TAPPIN G SCREW	1	PZ																																																							
VI1996A0	M5X35 SCREW	7	PZ																																																							
VM1794A0	250X4.8 PA66 BLACK CLAMP	2	PZ																																																							
VM2103A0	CLAMP LOCK	2	PZ																																																							
VM2259A1	6 SERIES DOOR LOWER LEFT CAP	1	PZ																																																							
VM2261A1	6 SERIES DOOR LOWER RIGHT CAP	1	PZ																																																							
VM2267A0	INTERNAL GLASS LOCKING SYSTEM SLIDER	1	PZ																																																							
VM2269A0	INTERNAL GLASS LOCKING SYSTEM CAP	1	PZ																																																							
VM2274A0	GROOVED BUSHING	1	PZ																																																							
VM2305A0	6 SERIES DOOR CAP FIXING PAWL	7	PZ																																																							
K0B1126AL	EU AND 2/1 MM LEFT DOOR LOWER BEAM KIT	<table border="1"> <thead> <tr> <th>Code</th> <th>Description</th> <th>Qty</th> <th>UOM</th> </tr> </thead> <tbody> <tr> <td>0B1126A0</td> <td>DOOR LOWER FRAME SHAPE 860 MM</td> <td>1</td> <td>PZ</td> </tr> <tr> <td>0B1126A1</td> <td></td> <td>1</td> <td>PZ</td> </tr> <tr> <td>RC1200A0</td> <td>ED=4 WIRE D.=0.5 COMPRESSIO N SPRING</td> <td>2</td> <td>PZ</td> </tr> <tr> <td>VI1220A1</td> <td>4,2X12 TCB SELF-TAPPIN G SCREW</td> <td>1</td> <td>PZ</td> </tr> <tr> <td>VI1996A0</td> <td>M5X35 SCREW</td> <td>7</td> <td>PZ</td> </tr> <tr> <td>VM1794A0</td> <td>250X4.8 PA66 BLACK CLAMP</td> <td>2</td> <td>PZ</td> </tr> </tbody> </table>	Code	Description	Qty	UOM	0B1126A0	DOOR LOWER FRAME SHAPE 860 MM	1	PZ	0B1126A1		1	PZ	RC1200A0	ED=4 WIRE D.=0.5 COMPRESSIO N SPRING	2	PZ	VI1220A1	4,2X12 TCB SELF-TAPPIN G SCREW	1	PZ	VI1996A0	M5X35 SCREW	7	PZ	VM1794A0	250X4.8 PA66 BLACK CLAMP	2	PZ																												
Code	Description	Qty	UOM																																																							
0B1126A0	DOOR LOWER FRAME SHAPE 860 MM	1	PZ																																																							
0B1126A1		1	PZ																																																							
RC1200A0	ED=4 WIRE D.=0.5 COMPRESSIO N SPRING	2	PZ																																																							
VI1220A1	4,2X12 TCB SELF-TAPPIN G SCREW	1	PZ																																																							
VI1996A0	M5X35 SCREW	7	PZ																																																							
VM1794A0	250X4.8 PA66 BLACK CLAMP	2	PZ																																																							









COMPONENT			SPARE PART																																										
Code	Description	Image	Code	Description	Components list																																								
VM2274A	GROOVED BUSHING		K0B1126AL	EU AND 2/1 MM LEFT DOOR LOWER BEAM KIT	<table border="1"> <thead> <tr> <th>Code</th> <th>Description</th> <th>Qty</th> <th>UOM</th> </tr> </thead> <tbody> <tr> <td>VM2103A0</td> <td>CLAMP LOCK</td> <td>2</td> <td>PZ</td> </tr> <tr> <td>VM2267A0</td> <td>INTERNAL GLASS LOCKING SYSTEM SLIDER</td> <td>1</td> <td>PZ</td> </tr> <tr> <td>VM2269A0</td> <td>INTERNAL GLASS LOCKING SYSTEM CAP</td> <td>1</td> <td>PZ</td> </tr> <tr> <td>VM2274A0</td> <td>GROOVED BUSHING</td> <td>1</td> <td>PZ</td> </tr> <tr> <td>VM2305A0</td> <td>6 SERIES DOOR CAP FIXING PAWL</td> <td>7</td> <td>PZ</td> </tr> <tr> <td>VM2384A0</td> <td>MM LEFT DOOR RIGHT LOWER CAP</td> <td>1</td> <td>PZ</td> </tr> <tr> <td>VM2384A0</td> <td>MM LEFT DOOR RIGHT LOWER CAP</td> <td>1</td> <td>PZ</td> </tr> <tr> <td>VM2386A1</td> <td>LEFT MM DOOR LOWER LEFT CAP</td> <td>1</td> <td>PZ</td> </tr> <tr> <td>VM2386A1</td> <td>LEFT MM DOOR LOWER LEFT CAP</td> <td>1</td> <td>PZ</td> </tr> </tbody> </table>	Code	Description	Qty	UOM	VM2103A0	CLAMP LOCK	2	PZ	VM2267A0	INTERNAL GLASS LOCKING SYSTEM SLIDER	1	PZ	VM2269A0	INTERNAL GLASS LOCKING SYSTEM CAP	1	PZ	VM2274A0	GROOVED BUSHING	1	PZ	VM2305A0	6 SERIES DOOR CAP FIXING PAWL	7	PZ	VM2384A0	MM LEFT DOOR RIGHT LOWER CAP	1	PZ	VM2384A0	MM LEFT DOOR RIGHT LOWER CAP	1	PZ	VM2386A1	LEFT MM DOOR LOWER LEFT CAP	1	PZ	VM2386A1	LEFT MM DOOR LOWER LEFT CAP	1	PZ
Code	Description	Qty	UOM																																										
VM2103A0	CLAMP LOCK	2	PZ																																										
VM2267A0	INTERNAL GLASS LOCKING SYSTEM SLIDER	1	PZ																																										
VM2269A0	INTERNAL GLASS LOCKING SYSTEM CAP	1	PZ																																										
VM2274A0	GROOVED BUSHING	1	PZ																																										
VM2305A0	6 SERIES DOOR CAP FIXING PAWL	7	PZ																																										
VM2384A0	MM LEFT DOOR RIGHT LOWER CAP	1	PZ																																										
VM2384A0	MM LEFT DOOR RIGHT LOWER CAP	1	PZ																																										
VM2386A1	LEFT MM DOOR LOWER LEFT CAP	1	PZ																																										
VM2386A1	LEFT MM DOOR LOWER LEFT CAP	1	PZ																																										
			K0B1122AR	CHEFTOP MM RIGHT DOOR LOWER BEAM KIT	<table border="1"> <thead> <tr> <th>Code</th> <th>Description</th> <th>Qty</th> <th>UOM</th> </tr> </thead> <tbody> <tr> <td>0B1122A0</td> <td>750MM DOOR LOWER FRAME SHAPE</td> <td>1</td> <td>PZ</td> </tr> <tr> <td>0B1122A1</td> <td>750MM DOOR LOWER FRAME SHAPE</td> <td>1</td> <td>PZ</td> </tr> <tr> <td>RC1200A0</td> <td>ED=4 WIRE D.=0.5 COMPRESSIO N SPRING</td> <td>2</td> <td>PZ</td> </tr> <tr> <td>VI1220A1</td> <td>4,2X12 TCB SELF-TAPPIN G SCREW</td> <td>1</td> <td>PZ</td> </tr> <tr> <td>VI1996A0</td> <td>M5X35 SCREW</td> <td>7</td> <td>PZ</td> </tr> <tr> <td>VM1794A0</td> <td>250X4.8 PA66 BLACK CLAMP</td> <td>2</td> <td>PZ</td> </tr> <tr> <td>VM2103A0</td> <td>CLAMP LOCK</td> <td>2</td> <td>PZ</td> </tr> <tr> <td>VM2259A1</td> <td>6 SERIES DOOR LOWER LEFT CAP</td> <td>1</td> <td>PZ</td> </tr> <tr> <td>VM2261A1</td> <td>6 SERIES DOOR LOWER RIGHT CAP</td> <td>1</td> <td>PZ</td> </tr> </tbody> </table>	Code	Description	Qty	UOM	0B1122A0	750MM DOOR LOWER FRAME SHAPE	1	PZ	0B1122A1	750MM DOOR LOWER FRAME SHAPE	1	PZ	RC1200A0	ED=4 WIRE D.=0.5 COMPRESSIO N SPRING	2	PZ	VI1220A1	4,2X12 TCB SELF-TAPPIN G SCREW	1	PZ	VI1996A0	M5X35 SCREW	7	PZ	VM1794A0	250X4.8 PA66 BLACK CLAMP	2	PZ	VM2103A0	CLAMP LOCK	2	PZ	VM2259A1	6 SERIES DOOR LOWER LEFT CAP	1	PZ	VM2261A1	6 SERIES DOOR LOWER RIGHT CAP	1	PZ
Code	Description	Qty	UOM																																										
0B1122A0	750MM DOOR LOWER FRAME SHAPE	1	PZ																																										
0B1122A1	750MM DOOR LOWER FRAME SHAPE	1	PZ																																										
RC1200A0	ED=4 WIRE D.=0.5 COMPRESSIO N SPRING	2	PZ																																										
VI1220A1	4,2X12 TCB SELF-TAPPIN G SCREW	1	PZ																																										
VI1996A0	M5X35 SCREW	7	PZ																																										
VM1794A0	250X4.8 PA66 BLACK CLAMP	2	PZ																																										
VM2103A0	CLAMP LOCK	2	PZ																																										
VM2259A1	6 SERIES DOOR LOWER LEFT CAP	1	PZ																																										
VM2261A1	6 SERIES DOOR LOWER RIGHT CAP	1	PZ																																										

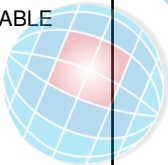

COMPONENT			SPARE PART																																																																		
Code	Description	Image	Code	Description	Components list																																																																
VM2274A	GROOVED BUSHING		K0B1122AR	CHEFTOP MM RIGHT DOOR LOWER BEAM KIT	<table border="1"> <thead> <tr> <th>Code</th> <th>Description</th> <th>Qty</th> <th>UOM</th> </tr> </thead> <tbody> <tr> <td>VM2267A0</td> <td>INTERNAL GLASS LOCKING SYSTEM SLIDER</td> <td>1</td> <td>PZ</td> </tr> <tr> <td>VM2269A0</td> <td>INTERNAL GLASS LOCKING SYSTEM CAP</td> <td>1</td> <td>PZ</td> </tr> <tr> <td>VM2274A0</td> <td>GROOVED BUSHING</td> <td>1</td> <td>PZ</td> </tr> <tr> <td>VM2305A0</td> <td>6 SERIES DOOR CAP FIXING PAWL</td> <td>7</td> <td>PZ</td> </tr> </tbody> </table>	Code	Description	Qty	UOM	VM2267A0	INTERNAL GLASS LOCKING SYSTEM SLIDER	1	PZ	VM2269A0	INTERNAL GLASS LOCKING SYSTEM CAP	1	PZ	VM2274A0	GROOVED BUSHING	1	PZ	VM2305A0	6 SERIES DOOR CAP FIXING PAWL	7	PZ																																												
Code	Description	Qty	UOM																																																																		
VM2267A0	INTERNAL GLASS LOCKING SYSTEM SLIDER	1	PZ																																																																		
VM2269A0	INTERNAL GLASS LOCKING SYSTEM CAP	1	PZ																																																																		
VM2274A0	GROOVED BUSHING	1	PZ																																																																		
VM2305A0	6 SERIES DOOR CAP FIXING PAWL	7	PZ																																																																		
			K0B1122AL	CHEFTOP MM LEFT DOOR LOWER BEAM KIT	<table border="1"> <thead> <tr> <th>Code</th> <th>Description</th> <th>Qty</th> <th>UOM</th> </tr> </thead> <tbody> <tr> <td>0B1122A0</td> <td>750MM DOOR LOWER FRAME SHAPE</td> <td>1</td> <td>PZ</td> </tr> <tr> <td>0B1122A1</td> <td>750MM DOOR LOWER FRAME SHAPE</td> <td>1</td> <td>PZ</td> </tr> <tr> <td>RC1200A0</td> <td>ED=4 WIRE D.=0.5 COMPRESSION N SPRING</td> <td>2</td> <td>PZ</td> </tr> <tr> <td>V11220A1</td> <td>4,2X12 TCB SELF-TAPPING G SCREW</td> <td>1</td> <td>PZ</td> </tr> <tr> <td>V11996A0</td> <td>M5X35 SCREW</td> <td>7</td> <td>PZ</td> </tr> <tr> <td>VM1794A0</td> <td>250X4.8 PA66 BLACK CLAMP</td> <td>2</td> <td>PZ</td> </tr> <tr> <td>VM2103A0</td> <td>CLAMP LOCK</td> <td>2</td> <td>PZ</td> </tr> <tr> <td>VM2267A0</td> <td>INTERNAL GLASS LOCKING SYSTEM SLIDER</td> <td>1</td> <td>PZ</td> </tr> <tr> <td>VM2269A0</td> <td>INTERNAL GLASS LOCKING SYSTEM CAP</td> <td>1</td> <td>PZ</td> </tr> <tr> <td>VM2274A0</td> <td>GROOVED BUSHING</td> <td>1</td> <td>PZ</td> </tr> <tr> <td>VM2305A0</td> <td>6 SERIES DOOR CAP FIXING PAWL</td> <td>7</td> <td>PZ</td> </tr> <tr> <td>VM2384A0</td> <td>MM LEFT DOOR RIGHT LOWER CAP</td> <td>1</td> <td>PZ</td> </tr> <tr> <td>VM2384A0</td> <td>MM LEFT DOOR RIGHT LOWER CAP</td> <td>1</td> <td>PZ</td> </tr> <tr> <td>VM2386A1</td> <td>LEFT MM DOOR LOWER LEFT CAP</td> <td>1</td> <td>PZ</td> </tr> <tr> <td>VM2386A1</td> <td>LEFT MM DOOR LOWER LEFT CAP</td> <td>1</td> <td>PZ</td> </tr> </tbody> </table>	Code	Description	Qty	UOM	0B1122A0	750MM DOOR LOWER FRAME SHAPE	1	PZ	0B1122A1	750MM DOOR LOWER FRAME SHAPE	1	PZ	RC1200A0	ED=4 WIRE D.=0.5 COMPRESSION N SPRING	2	PZ	V11220A1	4,2X12 TCB SELF-TAPPING G SCREW	1	PZ	V11996A0	M5X35 SCREW	7	PZ	VM1794A0	250X4.8 PA66 BLACK CLAMP	2	PZ	VM2103A0	CLAMP LOCK	2	PZ	VM2267A0	INTERNAL GLASS LOCKING SYSTEM SLIDER	1	PZ	VM2269A0	INTERNAL GLASS LOCKING SYSTEM CAP	1	PZ	VM2274A0	GROOVED BUSHING	1	PZ	VM2305A0	6 SERIES DOOR CAP FIXING PAWL	7	PZ	VM2384A0	MM LEFT DOOR RIGHT LOWER CAP	1	PZ	VM2384A0	MM LEFT DOOR RIGHT LOWER CAP	1	PZ	VM2386A1	LEFT MM DOOR LOWER LEFT CAP	1	PZ	VM2386A1	LEFT MM DOOR LOWER LEFT CAP	1	PZ
Code	Description	Qty	UOM																																																																		
0B1122A0	750MM DOOR LOWER FRAME SHAPE	1	PZ																																																																		
0B1122A1	750MM DOOR LOWER FRAME SHAPE	1	PZ																																																																		
RC1200A0	ED=4 WIRE D.=0.5 COMPRESSION N SPRING	2	PZ																																																																		
V11220A1	4,2X12 TCB SELF-TAPPING G SCREW	1	PZ																																																																		
V11996A0	M5X35 SCREW	7	PZ																																																																		
VM1794A0	250X4.8 PA66 BLACK CLAMP	2	PZ																																																																		
VM2103A0	CLAMP LOCK	2	PZ																																																																		
VM2267A0	INTERNAL GLASS LOCKING SYSTEM SLIDER	1	PZ																																																																		
VM2269A0	INTERNAL GLASS LOCKING SYSTEM CAP	1	PZ																																																																		
VM2274A0	GROOVED BUSHING	1	PZ																																																																		
VM2305A0	6 SERIES DOOR CAP FIXING PAWL	7	PZ																																																																		
VM2384A0	MM LEFT DOOR RIGHT LOWER CAP	1	PZ																																																																		
VM2384A0	MM LEFT DOOR RIGHT LOWER CAP	1	PZ																																																																		
VM2386A1	LEFT MM DOOR LOWER LEFT CAP	1	PZ																																																																		
VM2386A1	LEFT MM DOOR LOWER LEFT CAP	1	PZ																																																																		

COMPONENT			SPARE PART																										
Code	Description	Image	Code	Description	Components list																								
VM2275A	SMOOTH BUSHING		KVM2275A	SMOOTH PIN BUSHING KIT	<table border="1"> <thead> <tr> <th>Code</th> <th>Description</th> <th>Qty</th> <th>UOM</th> </tr> </thead> <tbody> <tr> <td>VM1224A0</td> <td></td> <td>0.150</td> <td>M</td> </tr> <tr> <td>VM2275A0</td> <td>SMOOTH BUSHING</td> <td>1</td> <td>PZ</td> </tr> </tbody> </table>	Code	Description	Qty	UOM	VM1224A0		0.150	M	VM2275A0	SMOOTH BUSHING	1	PZ												
Code	Description	Qty	UOM																										
VM1224A0		0.150	M																										
VM2275A0	SMOOTH BUSHING	1	PZ																										
CE1285A	EMI ROUND FERRITE MOD.2643801502		CE1285A0	EMI ROUND FERRITE MOD.2643801502																									
LP1050A	BL SHOP.PRO L180 COMPLETE LED BA		KLP1050A	BAKERLUX SHOP.PRO L180 LED BAR KIT	<table border="1"> <thead> <tr> <th>Code</th> <th>Description</th> <th>Qty</th> <th>UOM</th> </tr> </thead> <tbody> <tr> <td>IP1385A1</td> <td>CORNER POLYSTYREN E PACKING 110X80X2000</td> <td>0.300</td> <td>M</td> </tr> <tr> <td>LP1050A0</td> <td>BL SHOP.PRO L180 COMPLETE LED BAR</td> <td>1</td> <td>PZ</td> </tr> <tr> <td>VI1014A0</td> <td>STAINLESS STEEL WASHER 4.5X9X0.8</td> <td>1</td> <td>PZ</td> </tr> <tr> <td>VI1220A1</td> <td>4,2X12 TCB SELF-TAPPIN G SCREW</td> <td>1</td> <td>PZ</td> </tr> <tr> <td>VM1059A1</td> <td>HEAT SHRINK FILM H800</td> <td>0.300</td> <td>M</td> </tr> </tbody> </table>	Code	Description	Qty	UOM	IP1385A1	CORNER POLYSTYREN E PACKING 110X80X2000	0.300	M	LP1050A0	BL SHOP.PRO L180 COMPLETE LED BAR	1	PZ	VI1014A0	STAINLESS STEEL WASHER 4.5X9X0.8	1	PZ	VI1220A1	4,2X12 TCB SELF-TAPPIN G SCREW	1	PZ	VM1059A1	HEAT SHRINK FILM H800	0.300	M
Code	Description	Qty	UOM																										
IP1385A1	CORNER POLYSTYREN E PACKING 110X80X2000	0.300	M																										
LP1050A0	BL SHOP.PRO L180 COMPLETE LED BAR	1	PZ																										
VI1014A0	STAINLESS STEEL WASHER 4.5X9X0.8	1	PZ																										
VI1220A1	4,2X12 TCB SELF-TAPPIN G SCREW	1	PZ																										
VM1059A1	HEAT SHRINK FILM H800	0.300	M																										
VM2512A	BL SP DOOR-MICROSWITC H SOFT CLOSING		KVM2512A	BL SP DOOR-MICROSWITC H SOFT CLOSING KI	<table border="1"> <thead> <tr> <th>Code</th> <th>Description</th> <th>Qty</th> <th>UOM</th> </tr> </thead> <tbody> <tr> <td>VM1224A0</td> <td></td> <td>0.250</td> <td>M</td> </tr> <tr> <td>VM2512A0</td> <td>BL SP DOOR-MICRO SWITCH SOFT CLOSING</td> <td>1</td> <td>PZ</td> </tr> <tr> <td>VM2512A0</td> <td>BL SP DOOR-MICRO SWITCH SOFT CLOSING</td> <td>1</td> <td>PZ</td> </tr> </tbody> </table>	Code	Description	Qty	UOM	VM1224A0		0.250	M	VM2512A0	BL SP DOOR-MICRO SWITCH SOFT CLOSING	1	PZ	VM2512A0	BL SP DOOR-MICRO SWITCH SOFT CLOSING	1	PZ								
Code	Description	Qty	UOM																										
VM1224A0		0.250	M																										
VM2512A0	BL SP DOOR-MICRO SWITCH SOFT CLOSING	1	PZ																										
VM2512A0	BL SP DOOR-MICRO SWITCH SOFT CLOSING	1	PZ																										

COMPONENT			SPARE PART																						
Code	Description	Image	Code	Description	Components list																				
VM1630A	INTERNAL GLASS PUSHING CAP		KVM1630A	CAP FOR INTERNAL GLASS 10 PCS KIT	<table border="1"> <thead> <tr> <th>Code</th> <th>Description</th> <th>Qty</th> <th>UOM</th> </tr> </thead> <tbody> <tr> <td>VM1224A0</td> <td></td> <td>0.200</td> <td>M</td> </tr> <tr> <td>VM1630A0</td> <td>INTERNAL GLASS PUSHING CAP</td> <td>10</td> <td>PZ</td> </tr> </tbody> </table>	Code	Description	Qty	UOM	VM1224A0		0.200	M	VM1630A0	INTERNAL GLASS PUSHING CAP	10	PZ								
Code	Description	Qty	UOM																						
VM1224A0		0.200	M																						
VM1630A0	INTERNAL GLASS PUSHING CAP	10	PZ																						
VM2479A	BL SP GLASS H6 PUSHING BRACKET		KVM2479A	BL SHOP.PRO H6 GLASS SUPPORT 6 PCS KIT	<table border="1"> <thead> <tr> <th>Code</th> <th>Description</th> <th>Qty</th> <th>UOM</th> </tr> </thead> <tbody> <tr> <td>VM1224A0</td> <td></td> <td>0.200</td> <td>M</td> </tr> <tr> <td>VM1630A0</td> <td>INTERNAL GLASS PUSHING CAP</td> <td>6</td> <td>PZ</td> </tr> <tr> <td>VM2479A0</td> <td>BL SP GLASS H6 PUSHING BRACKET</td> <td>6</td> <td>PZ</td> </tr> <tr> <td>VM2479A0</td> <td>BL SP GLASS H6 PUSHING BRACKET</td> <td>6</td> <td>PZ</td> </tr> </tbody> </table>	Code	Description	Qty	UOM	VM1224A0		0.200	M	VM1630A0	INTERNAL GLASS PUSHING CAP	6	PZ	VM2479A0	BL SP GLASS H6 PUSHING BRACKET	6	PZ	VM2479A0	BL SP GLASS H6 PUSHING BRACKET	6	PZ
Code	Description	Qty	UOM																						
VM1224A0		0.200	M																						
VM1630A0	INTERNAL GLASS PUSHING CAP	6	PZ																						
VM2479A0	BL SP GLASS H6 PUSHING BRACKET	6	PZ																						
VM2479A0	BL SP GLASS H6 PUSHING BRACKET	6	PZ																						
CE1096A	4 POLES MICROFIT 3 M BUS CABLE		KCE1096A	4 POLES MICROFIT 3 METRES BUS CABLE KIT	<table border="1"> <thead> <tr> <th>Code</th> <th>Description</th> <th>Qty</th> <th>UOM</th> </tr> </thead> <tbody> <tr> <td>CE1096A0</td> <td>4 POLES MICROFIT 3 M BUS CABLE</td> <td>1</td> <td>PZ</td> </tr> <tr> <td>VM1224A0</td> <td></td> <td>0.250</td> <td>M</td> </tr> </tbody> </table>	Code	Description	Qty	UOM	CE1096A0	4 POLES MICROFIT 3 M BUS CABLE	1	PZ	VM1224A0		0.250	M								
Code	Description	Qty	UOM																						
CE1096A0	4 POLES MICROFIT 3 M BUS CABLE	1	PZ																						
VM1224A0		0.250	M																						
0B1306A			0B1306A0																						
VT1328A			KVT1328A	BL SHOP.PRO CAMILLA EXTERNAL GLASS KIT	<table border="1"> <thead> <tr> <th>Code</th> <th>Description</th> <th>Qty</th> <th>UOM</th> </tr> </thead> <tbody> <tr> <td>0B0389A0</td> <td></td> <td>2</td> <td>PZ</td> </tr> <tr> <td>ED1240A0</td> <td>TECHNICAL DATA LABEL</td> <td>1</td> <td>PZ</td> </tr> <tr> <td>IP1385A1</td> <td>CORNER POLYSTYREN E PACKING 110X80X2000</td> <td>1.800</td> <td>M</td> </tr> <tr> <td>IP1508A1</td> <td>POLYSTYREN E U SHAPED PROFILE 2000X60X60</td> <td>1.200</td> <td>M</td> </tr> </tbody> </table>	Code	Description	Qty	UOM	0B0389A0		2	PZ	ED1240A0	TECHNICAL DATA LABEL	1	PZ	IP1385A1	CORNER POLYSTYREN E PACKING 110X80X2000	1.800	M	IP1508A1	POLYSTYREN E U SHAPED PROFILE 2000X60X60	1.200	M
Code	Description	Qty	UOM																						
0B0389A0		2	PZ																						
ED1240A0	TECHNICAL DATA LABEL	1	PZ																						
IP1385A1	CORNER POLYSTYREN E PACKING 110X80X2000	1.800	M																						
IP1508A1	POLYSTYREN E U SHAPED PROFILE 2000X60X60	1.200	M																						

COMPONENT			SPARE PART																																																																							
Code	Description	Image	Code	Description	Components list																																																																					
VT1328A			KVT1328A	BL SHOP.PRO CAMILLA EXTERNAL GLASS KIT	<table border="1"> <thead> <tr> <th>Code</th> <th>Description</th> <th>Qty</th> <th>UOM</th> </tr> </thead> <tbody> <tr> <td>SL1155A1</td> <td>LOCTITE BICOMPONEN T SILICON</td> <td>34</td> <td>ML</td> </tr> <tr> <td>VI1220A1</td> <td>4,2X12 TCB SELF-TAPPIN G SCREW</td> <td>6</td> <td>PZ</td> </tr> <tr> <td>VM1059A1</td> <td>HEAT SHRINK FILM H800</td> <td>2.200</td> <td>M</td> </tr> <tr> <td>VT1328A1</td> <td></td> <td>1</td> <td>PZ</td> </tr> <tr> <td>VT1328A1</td> <td></td> <td>1</td> <td>PZ</td> </tr> </tbody> </table>	Code	Description	Qty	UOM	SL1155A1	LOCTITE BICOMPONEN T SILICON	34	ML	VI1220A1	4,2X12 TCB SELF-TAPPIN G SCREW	6	PZ	VM1059A1	HEAT SHRINK FILM H800	2.200	M	VT1328A1		1	PZ	VT1328A1		1	PZ																																													
			Code	Description	Qty	UOM																																																																				
SL1155A1	LOCTITE BICOMPONEN T SILICON	34	ML																																																																							
VI1220A1	4,2X12 TCB SELF-TAPPIN G SCREW	6	PZ																																																																							
VM1059A1	HEAT SHRINK FILM H800	2.200	M																																																																							
VT1328A1		1	PZ																																																																							
VT1328A1		1	PZ																																																																							
KDR1365A	BLSP CAMILLA GO-LED-MT EXT LEFT DOOR KIT	<table border="1"> <thead> <tr> <th>Code</th> <th>Description</th> <th>Qty</th> <th>UOM</th> </tr> </thead> <tbody> <tr> <td>OB1323A0</td> <td></td> <td>1</td> <td>PZ</td> </tr> <tr> <td>OB1324A0</td> <td></td> <td>1</td> <td>PZ</td> </tr> <tr> <td>OB1364A0</td> <td></td> <td>1</td> <td>PZ</td> </tr> <tr> <td>OB1365A0</td> <td></td> <td>1</td> <td>PZ</td> </tr> <tr> <td>ED1240A0</td> <td>TECHNICAL DATA LABEL</td> <td>1</td> <td>PZ</td> </tr> <tr> <td>IP1325B0</td> <td>POLYSTYREN E CORNER PACKING D20</td> <td>1.450</td> <td>PZ</td> </tr> <tr> <td>IP1385A1</td> <td>CORNER POLYSTYREN E PACKING 110X80X2000</td> <td>0.900</td> <td>M</td> </tr> <tr> <td>IP1508A1</td> <td>POLYSTYREN E U SHAPED PROFILE 2000X60X60</td> <td>1.200</td> <td>M</td> </tr> <tr> <td>ML1005A0</td> <td></td> <td>2</td> <td>PZ</td> </tr> <tr> <td>ML1006A0</td> <td>ST STEEL TRACTION SPRING L.21 ED7 DF1</td> <td>2</td> <td>PZ</td> </tr> <tr> <td>SL1155A1</td> <td>LOCTITE BICOMPONEN T SILICON</td> <td>34</td> <td>ML</td> </tr> <tr> <td>TB1563A0</td> <td>DOOR LATERAL BEAM SP800</td> <td>2</td> <td>PZ</td> </tr> <tr> <td>TB1724A0</td> <td>CAMILLA SHOP PRO PUSH TO CLOSE PIPE</td> <td>1</td> <td>PZ</td> </tr> <tr> <td>TB3306A0</td> <td></td> <td>1</td> <td>PZ</td> </tr> <tr> <td>VI1014A0</td> <td>STAINLESS STEEL WASHER 4.5X9X0.8</td> <td>2</td> <td>PZ</td> </tr> <tr> <td>VI1024A0</td> <td>SCREW M4X12 TCB + INOX DIN 7985</td> <td>2</td> <td>PZ</td> </tr> <tr> <td>VI1220A1</td> <td>4,2X12 TCB SELF-TAPPIN G SCREW</td> <td>20</td> <td>PZ</td> </tr> </tbody> </table>	Code	Description	Qty	UOM	OB1323A0		1	PZ	OB1324A0		1	PZ	OB1364A0		1	PZ	OB1365A0		1	PZ	ED1240A0	TECHNICAL DATA LABEL	1	PZ	IP1325B0	POLYSTYREN E CORNER PACKING D20	1.450	PZ	IP1385A1	CORNER POLYSTYREN E PACKING 110X80X2000	0.900	M	IP1508A1	POLYSTYREN E U SHAPED PROFILE 2000X60X60	1.200	M	ML1005A0		2	PZ	ML1006A0	ST STEEL TRACTION SPRING L.21 ED7 DF1	2	PZ	SL1155A1	LOCTITE BICOMPONEN T SILICON	34	ML	TB1563A0	DOOR LATERAL BEAM SP800	2	PZ	TB1724A0	CAMILLA SHOP PRO PUSH TO CLOSE PIPE	1	PZ	TB3306A0		1	PZ	VI1014A0	STAINLESS STEEL WASHER 4.5X9X0.8	2	PZ	VI1024A0	SCREW M4X12 TCB + INOX DIN 7985	2	PZ	VI1220A1	4,2X12 TCB SELF-TAPPIN G SCREW	20	PZ
Code	Description	Qty	UOM																																																																							
OB1323A0		1	PZ																																																																							
OB1324A0		1	PZ																																																																							
OB1364A0		1	PZ																																																																							
OB1365A0		1	PZ																																																																							
ED1240A0	TECHNICAL DATA LABEL	1	PZ																																																																							
IP1325B0	POLYSTYREN E CORNER PACKING D20	1.450	PZ																																																																							
IP1385A1	CORNER POLYSTYREN E PACKING 110X80X2000	0.900	M																																																																							
IP1508A1	POLYSTYREN E U SHAPED PROFILE 2000X60X60	1.200	M																																																																							
ML1005A0		2	PZ																																																																							
ML1006A0	ST STEEL TRACTION SPRING L.21 ED7 DF1	2	PZ																																																																							
SL1155A1	LOCTITE BICOMPONEN T SILICON	34	ML																																																																							
TB1563A0	DOOR LATERAL BEAM SP800	2	PZ																																																																							
TB1724A0	CAMILLA SHOP PRO PUSH TO CLOSE PIPE	1	PZ																																																																							
TB3306A0		1	PZ																																																																							
VI1014A0	STAINLESS STEEL WASHER 4.5X9X0.8	2	PZ																																																																							
VI1024A0	SCREW M4X12 TCB + INOX DIN 7985	2	PZ																																																																							
VI1220A1	4,2X12 TCB SELF-TAPPIN G SCREW	20	PZ																																																																							



COMPONENT			SPARE PART																																																																						
Code	Description	Image	Code	Description	Components list																																																																				
VT1328A			KDR1365A	BLSP CAMILLA GO-LED-MT EXT LEFT DOOR KIT	<table border="1"> <thead> <tr> <th>Code</th> <th>Description</th> <th>Qty</th> <th>UOM</th> </tr> </thead> <tbody> <tr> <td>VI1716A0</td> <td>STAINLESS STEEL BLIND THREADED SCREW M4</td> <td>2</td> <td>PZ</td> </tr> <tr> <td>VI1930A0</td> <td>5X25 ST. STEEL SCREW CHIP</td> <td>26</td> <td>PZ</td> </tr> <tr> <td>VM1059A1</td> <td>HEAT SHRINK FILM H800</td> <td>2</td> <td>M</td> </tr> <tr> <td>VM1630A0</td> <td>INTERNAL GLASS PUSHING CAP</td> <td>6</td> <td>PZ</td> </tr> <tr> <td>VM2274A0</td> <td>GROOVED BUSHING</td> <td>1</td> <td>PZ</td> </tr> <tr> <td>VM2275A0</td> <td>SMOOTH BUSHING</td> <td>1</td> <td>PZ</td> </tr> <tr> <td>VM2456A0</td> <td>BAKERLUX SHOP.PRO HANDLE END</td> <td>1</td> <td>PZ</td> </tr> <tr> <td>VM2466A0</td> <td>BL SP LEFT LOWER LATERAL DOOR CAP</td> <td>1</td> <td>PZ</td> </tr> <tr> <td>VM2468A0</td> <td>BL SP LEFT UPPER LATERAL DOOR CAP</td> <td>1</td> <td>PZ</td> </tr> <tr> <td>VM2470A0</td> <td>SLIDE TO FIX INTERNAL GLASS SHOP.PRO</td> <td>2</td> <td>PZ</td> </tr> <tr> <td>VM2471A0</td> <td>BL SP LOWER CLAMP INT LOCK GLASS SLIDER</td> <td>1</td> <td>PZ</td> </tr> <tr> <td>VM2472A0</td> <td>BL SP UPPER CLAMP INT LOCK GLASS SLIDER</td> <td>1</td> <td>PZ</td> </tr> <tr> <td>VM2473A0</td> <td>BL SP INT GLASS HINGE LOWER LOCK PIN</td> <td>1</td> <td>PZ</td> </tr> <tr> <td>VM2474A0</td> <td>BL SP INT GLASS HINGE UPPER LOCK PIN</td> <td>1</td> <td>PZ</td> </tr> <tr> <td>VM2479A0</td> <td>BL SP GLASS H6 PUSHING BRACKET</td> <td>6</td> <td>PZ</td> </tr> <tr> <td>VM2489A0</td> <td>SP HANDLE END KIT + STYLUS KIT</td> <td>1</td> <td>PZ</td> </tr> </tbody> </table>	Code	Description	Qty	UOM	VI1716A0	STAINLESS STEEL BLIND THREADED SCREW M4	2	PZ	VI1930A0	5X25 ST. STEEL SCREW CHIP	26	PZ	VM1059A1	HEAT SHRINK FILM H800	2	M	VM1630A0	INTERNAL GLASS PUSHING CAP	6	PZ	VM2274A0	GROOVED BUSHING	1	PZ	VM2275A0	SMOOTH BUSHING	1	PZ	VM2456A0	BAKERLUX SHOP.PRO HANDLE END	1	PZ	VM2466A0	BL SP LEFT LOWER LATERAL DOOR CAP	1	PZ	VM2468A0	BL SP LEFT UPPER LATERAL DOOR CAP	1	PZ	VM2470A0	SLIDE TO FIX INTERNAL GLASS SHOP.PRO	2	PZ	VM2471A0	BL SP LOWER CLAMP INT LOCK GLASS SLIDER	1	PZ	VM2472A0	BL SP UPPER CLAMP INT LOCK GLASS SLIDER	1	PZ	VM2473A0	BL SP INT GLASS HINGE LOWER LOCK PIN	1	PZ	VM2474A0	BL SP INT GLASS HINGE UPPER LOCK PIN	1	PZ	VM2479A0	BL SP GLASS H6 PUSHING BRACKET	6	PZ	VM2489A0	SP HANDLE END KIT + STYLUS KIT	1	PZ
Code	Description	Qty	UOM																																																																						
VI1716A0	STAINLESS STEEL BLIND THREADED SCREW M4	2	PZ																																																																						
VI1930A0	5X25 ST. STEEL SCREW CHIP	26	PZ																																																																						
VM1059A1	HEAT SHRINK FILM H800	2	M																																																																						
VM1630A0	INTERNAL GLASS PUSHING CAP	6	PZ																																																																						
VM2274A0	GROOVED BUSHING	1	PZ																																																																						
VM2275A0	SMOOTH BUSHING	1	PZ																																																																						
VM2456A0	BAKERLUX SHOP.PRO HANDLE END	1	PZ																																																																						
VM2466A0	BL SP LEFT LOWER LATERAL DOOR CAP	1	PZ																																																																						
VM2468A0	BL SP LEFT UPPER LATERAL DOOR CAP	1	PZ																																																																						
VM2470A0	SLIDE TO FIX INTERNAL GLASS SHOP.PRO	2	PZ																																																																						
VM2471A0	BL SP LOWER CLAMP INT LOCK GLASS SLIDER	1	PZ																																																																						
VM2472A0	BL SP UPPER CLAMP INT LOCK GLASS SLIDER	1	PZ																																																																						
VM2473A0	BL SP INT GLASS HINGE LOWER LOCK PIN	1	PZ																																																																						
VM2474A0	BL SP INT GLASS HINGE UPPER LOCK PIN	1	PZ																																																																						
VM2479A0	BL SP GLASS H6 PUSHING BRACKET	6	PZ																																																																						
VM2489A0	SP HANDLE END KIT + STYLUS KIT	1	PZ																																																																						



COMPONENT			SPARE PART																																																		
Code	Description	Image	Code	Description	Components list																																																
VT1328A			KDR1365A	BLSP CAMILLA GO-LED-MT EXT LEFT DOOR KIT	<table border="1"> <thead> <tr> <th>Code</th> <th>Description</th> <th>Qty</th> <th>UOM</th> </tr> </thead> <tbody> <tr> <td>VM2504A0</td> <td>DOWEL TO GUIDE SLIDE SPRING SHOP.PRO</td> <td>2</td> <td>PZ</td> </tr> <tr> <td>VM2506A0</td> <td>SP MECH. RIGHT LOWER LATERAL DOOR CAP</td> <td>1</td> <td>PZ</td> </tr> <tr> <td>VM2507A0</td> <td>SP MECH. RIGHT UPPER LATERAL DOOR CAP</td> <td>1</td> <td>PZ</td> </tr> <tr> <td>VM2512A0</td> <td>BL SP DOOR-MICRO SWITCH SOFT CLOSING</td> <td>2</td> <td>PZ</td> </tr> <tr> <td>VM2527A0</td> <td>STYLUS PEN FOR SP</td> <td>1</td> <td>PZ</td> </tr> <tr> <td>VM2546A0</td> <td>SHOP PRO PUSH TO CLOSE DOOR HOOK COVER</td> <td>1</td> <td>PZ</td> </tr> <tr> <td>VM2546A1</td> <td>SP COVER PUSH-TO-CLO SE DOOR HOO</td> <td>1</td> <td>PZ</td> </tr> <tr> <td>VM2548A0</td> <td>PUSH-TO-CLO SE DOOR INT PIPE GUIDE</td> <td>1</td> <td>PZ</td> </tr> <tr> <td>VM2548A1</td> <td>PUSH-TO-CLO SE DOOR INT PIPE GUIDE</td> <td>1</td> <td>PZ</td> </tr> <tr> <td>VM2549A0</td> <td>SP PUSH-TO-CLO SE DOOR HANDLE SPRING EYEL</td> <td>2</td> <td>PZ</td> </tr> <tr> <td>VT1328A1</td> <td></td> <td>1</td> <td>PZ</td> </tr> </tbody> </table>	Code	Description	Qty	UOM	VM2504A0	DOWEL TO GUIDE SLIDE SPRING SHOP.PRO	2	PZ	VM2506A0	SP MECH. RIGHT LOWER LATERAL DOOR CAP	1	PZ	VM2507A0	SP MECH. RIGHT UPPER LATERAL DOOR CAP	1	PZ	VM2512A0	BL SP DOOR-MICRO SWITCH SOFT CLOSING	2	PZ	VM2527A0	STYLUS PEN FOR SP	1	PZ	VM2546A0	SHOP PRO PUSH TO CLOSE DOOR HOOK COVER	1	PZ	VM2546A1	SP COVER PUSH-TO-CLO SE DOOR HOO	1	PZ	VM2548A0	PUSH-TO-CLO SE DOOR INT PIPE GUIDE	1	PZ	VM2548A1	PUSH-TO-CLO SE DOOR INT PIPE GUIDE	1	PZ	VM2549A0	SP PUSH-TO-CLO SE DOOR HANDLE SPRING EYEL	2	PZ	VT1328A1		1	PZ
			Code	Description	Qty	UOM																																															
VM2504A0	DOWEL TO GUIDE SLIDE SPRING SHOP.PRO	2	PZ																																																		
VM2506A0	SP MECH. RIGHT LOWER LATERAL DOOR CAP	1	PZ																																																		
VM2507A0	SP MECH. RIGHT UPPER LATERAL DOOR CAP	1	PZ																																																		
VM2512A0	BL SP DOOR-MICRO SWITCH SOFT CLOSING	2	PZ																																																		
VM2527A0	STYLUS PEN FOR SP	1	PZ																																																		
VM2546A0	SHOP PRO PUSH TO CLOSE DOOR HOOK COVER	1	PZ																																																		
VM2546A1	SP COVER PUSH-TO-CLO SE DOOR HOO	1	PZ																																																		
VM2548A0	PUSH-TO-CLO SE DOOR INT PIPE GUIDE	1	PZ																																																		
VM2548A1	PUSH-TO-CLO SE DOOR INT PIPE GUIDE	1	PZ																																																		
VM2549A0	SP PUSH-TO-CLO SE DOOR HANDLE SPRING EYEL	2	PZ																																																		
VT1328A1		1	PZ																																																		
			KDR1364A	BLSP GO-LED-MT CAMILLA EXT DOOR KIT	<table border="1"> <thead> <tr> <th>Code</th> <th>Description</th> <th>Qty</th> <th>UOM</th> </tr> </thead> <tbody> <tr> <td>0B1305A0</td> <td></td> <td>1</td> <td>PZ</td> </tr> <tr> <td>0B1306A0</td> <td></td> <td>1</td> <td>PZ</td> </tr> <tr> <td>0B1364A0</td> <td></td> <td>1</td> <td>PZ</td> </tr> <tr> <td>0B1365A0</td> <td></td> <td>1</td> <td>PZ</td> </tr> <tr> <td>ED1240A0</td> <td>TECHNICAL DATA LABEL</td> <td>1</td> <td>PZ</td> </tr> <tr> <td>IP1325B0</td> <td>POLYSTYREN E CORNER PACKING D20</td> <td>1.450</td> <td>PZ</td> </tr> <tr> <td>IP1385A1</td> <td>CORNER POLYSTYREN E PACKING 110X80X2000</td> <td>0.900</td> <td>M</td> </tr> </tbody> </table>	Code	Description	Qty	UOM	0B1305A0		1	PZ	0B1306A0		1	PZ	0B1364A0		1	PZ	0B1365A0		1	PZ	ED1240A0	TECHNICAL DATA LABEL	1	PZ	IP1325B0	POLYSTYREN E CORNER PACKING D20	1.450	PZ	IP1385A1	CORNER POLYSTYREN E PACKING 110X80X2000	0.900	M																
Code	Description	Qty	UOM																																																		
0B1305A0		1	PZ																																																		
0B1306A0		1	PZ																																																		
0B1364A0		1	PZ																																																		
0B1365A0		1	PZ																																																		
ED1240A0	TECHNICAL DATA LABEL	1	PZ																																																		
IP1325B0	POLYSTYREN E CORNER PACKING D20	1.450	PZ																																																		
IP1385A1	CORNER POLYSTYREN E PACKING 110X80X2000	0.900	M																																																		



COMPONENT			SPARE PART																																																																														
Code	Description	Image	Code	Description	Components list																																																																												
VT1328A			KDR1364A	BLSP GO-LED-MT CAMILLA EXT DOOR KIT	<table border="1"> <thead> <tr> <th>Code</th> <th>Description</th> <th>Qty</th> <th>UOM</th> </tr> </thead> <tbody> <tr> <td>IP1508A1</td> <td>POLYSTYREN E U SHAPED PROFILE 2000X60X60</td> <td>1.200</td> <td>M</td> </tr> <tr> <td>ML1005A0</td> <td></td> <td>2</td> <td>PZ</td> </tr> <tr> <td>ML1006A0</td> <td>ST STEEL TRACTION SPRING L.21 ED7 DF1</td> <td>2</td> <td>PZ</td> </tr> <tr> <td>SL1155A1</td> <td>LOCTITE BICOMPONEN T SILICON</td> <td>34</td> <td>ML</td> </tr> <tr> <td>TB1563A0</td> <td>DOOR LATERAL BEAM SP800</td> <td>2</td> <td>PZ</td> </tr> <tr> <td>TB1724A0</td> <td>CAMILLA SHOP PRO PUSH TO CLOSE PIPE</td> <td>1</td> <td>PZ</td> </tr> <tr> <td>TB3306A0</td> <td></td> <td>1</td> <td>PZ</td> </tr> <tr> <td>VI1014A0</td> <td>STAINLESS STEEL WASHER 4.5X9X0.8</td> <td>2</td> <td>PZ</td> </tr> <tr> <td>VI1024A0</td> <td>SCREW M4X12 TCB + INOX DIN 7985</td> <td>2</td> <td>PZ</td> </tr> <tr> <td>VI1220A1</td> <td>4,2X12 TCB SELF-TAPPIN G SCREW</td> <td>20</td> <td>PZ</td> </tr> <tr> <td>VI1716A0</td> <td>STAINLESS STEEL BLIND THREADED SCREW M4</td> <td>2</td> <td>PZ</td> </tr> <tr> <td>VI1930A0</td> <td>5X25 ST. STEEL SCREW CHIP</td> <td>26</td> <td>PZ</td> </tr> <tr> <td>VM1059A1</td> <td>HEAT SHRINK FILM H800</td> <td>2</td> <td>M</td> </tr> <tr> <td>VM1630A0</td> <td>INTERNAL GLASS PUSHING CAP</td> <td>6</td> <td>PZ</td> </tr> <tr> <td>VM2274A0</td> <td>GROOVED BUSHING</td> <td>1</td> <td>PZ</td> </tr> <tr> <td>VM2275A0</td> <td>SMOOTH BUSHING</td> <td>1</td> <td>PZ</td> </tr> <tr> <td>VM2456A0</td> <td>BAKERLUX SHOP.PRO HANDLE END</td> <td>1</td> <td>PZ</td> </tr> <tr> <td>VM2466A0</td> <td>BL SP LEFT LOWER LATERAL DOOR CAP</td> <td>1</td> <td>PZ</td> </tr> </tbody> </table>	Code	Description	Qty	UOM	IP1508A1	POLYSTYREN E U SHAPED PROFILE 2000X60X60	1.200	M	ML1005A0		2	PZ	ML1006A0	ST STEEL TRACTION SPRING L.21 ED7 DF1	2	PZ	SL1155A1	LOCTITE BICOMPONEN T SILICON	34	ML	TB1563A0	DOOR LATERAL BEAM SP800	2	PZ	TB1724A0	CAMILLA SHOP PRO PUSH TO CLOSE PIPE	1	PZ	TB3306A0		1	PZ	VI1014A0	STAINLESS STEEL WASHER 4.5X9X0.8	2	PZ	VI1024A0	SCREW M4X12 TCB + INOX DIN 7985	2	PZ	VI1220A1	4,2X12 TCB SELF-TAPPIN G SCREW	20	PZ	VI1716A0	STAINLESS STEEL BLIND THREADED SCREW M4	2	PZ	VI1930A0	5X25 ST. STEEL SCREW CHIP	26	PZ	VM1059A1	HEAT SHRINK FILM H800	2	M	VM1630A0	INTERNAL GLASS PUSHING CAP	6	PZ	VM2274A0	GROOVED BUSHING	1	PZ	VM2275A0	SMOOTH BUSHING	1	PZ	VM2456A0	BAKERLUX SHOP.PRO HANDLE END	1	PZ	VM2466A0	BL SP LEFT LOWER LATERAL DOOR CAP	1	PZ
Code	Description	Qty	UOM																																																																														
IP1508A1	POLYSTYREN E U SHAPED PROFILE 2000X60X60	1.200	M																																																																														
ML1005A0		2	PZ																																																																														
ML1006A0	ST STEEL TRACTION SPRING L.21 ED7 DF1	2	PZ																																																																														
SL1155A1	LOCTITE BICOMPONEN T SILICON	34	ML																																																																														
TB1563A0	DOOR LATERAL BEAM SP800	2	PZ																																																																														
TB1724A0	CAMILLA SHOP PRO PUSH TO CLOSE PIPE	1	PZ																																																																														
TB3306A0		1	PZ																																																																														
VI1014A0	STAINLESS STEEL WASHER 4.5X9X0.8	2	PZ																																																																														
VI1024A0	SCREW M4X12 TCB + INOX DIN 7985	2	PZ																																																																														
VI1220A1	4,2X12 TCB SELF-TAPPIN G SCREW	20	PZ																																																																														
VI1716A0	STAINLESS STEEL BLIND THREADED SCREW M4	2	PZ																																																																														
VI1930A0	5X25 ST. STEEL SCREW CHIP	26	PZ																																																																														
VM1059A1	HEAT SHRINK FILM H800	2	M																																																																														
VM1630A0	INTERNAL GLASS PUSHING CAP	6	PZ																																																																														
VM2274A0	GROOVED BUSHING	1	PZ																																																																														
VM2275A0	SMOOTH BUSHING	1	PZ																																																																														
VM2456A0	BAKERLUX SHOP.PRO HANDLE END	1	PZ																																																																														
VM2466A0	BL SP LEFT LOWER LATERAL DOOR CAP	1	PZ																																																																														



COMPONENT			SPARE PART																																																																		
Code	Description	Image	Code	Description	Components list																																																																
VT1328A			KDR1364A	BLSP GO-LED-MT CAMILLA EXT DOOR KIT	<table border="1"> <thead> <tr> <th>Code</th> <th>Description</th> <th>Qty</th> <th>UOM</th> </tr> </thead> <tbody> <tr> <td>VM2468A0</td> <td>BL SP LEFT UPPER LATERAL DOOR CAP</td> <td>1</td> <td>PZ</td> </tr> <tr> <td>VM2470A0</td> <td>SLIDE TO FIX INTERNAL GLASS SHOP.PRO</td> <td>2</td> <td>PZ</td> </tr> <tr> <td>VM2471A0</td> <td>BL SP LOWER CLAMP INT LOCK GLASS SLIDER</td> <td>1</td> <td>PZ</td> </tr> <tr> <td>VM2472A0</td> <td>BL SP UPPER CLAMP INT LOCK GLASS SLIDER</td> <td>1</td> <td>PZ</td> </tr> <tr> <td>VM2473A0</td> <td>BL SP INT GLASS HINGE LOWER LOCK PIN</td> <td>1</td> <td>PZ</td> </tr> <tr> <td>VM2474A0</td> <td>BL SP INT GLASS HINGE UPPER LOCK PIN</td> <td>1</td> <td>PZ</td> </tr> <tr> <td>VM2479A0</td> <td>BL SP GLASS H6 PUSHING BRACKET</td> <td>6</td> <td>PZ</td> </tr> <tr> <td>VM2489A0</td> <td>SP HANDLE END KIT + STYLUS KIT</td> <td>1</td> <td>PZ</td> </tr> <tr> <td>VM2504A0</td> <td>DOWEL TO GUIDE SLIDE SPRING SHOP.PRO</td> <td>2</td> <td>PZ</td> </tr> <tr> <td>VM2506A0</td> <td>SP MECH. RIGHT LOWER LATERAL DOOR CAP</td> <td>1</td> <td>PZ</td> </tr> <tr> <td>VM2507A0</td> <td>SP MECH. RIGHT UPPER LATERAL DOOR CAP</td> <td>1</td> <td>PZ</td> </tr> <tr> <td>VM2512A0</td> <td>BL SP DOOR-MICRO SWITCH SOFT CLOSING</td> <td>2</td> <td>PZ</td> </tr> <tr> <td>VM2527A0</td> <td>STYLUS PEN FOR SP</td> <td>1</td> <td>PZ</td> </tr> <tr> <td>VM2546A0</td> <td>SHOP PRO PUSH TO CLOSE DOOR HOOK COVER</td> <td>1</td> <td>PZ</td> </tr> <tr> <td>VM2546A1</td> <td>SP COVER PUSH-TO-CLO SE DOOR HOO</td> <td>1</td> <td>PZ</td> </tr> </tbody> </table>	Code	Description	Qty	UOM	VM2468A0	BL SP LEFT UPPER LATERAL DOOR CAP	1	PZ	VM2470A0	SLIDE TO FIX INTERNAL GLASS SHOP.PRO	2	PZ	VM2471A0	BL SP LOWER CLAMP INT LOCK GLASS SLIDER	1	PZ	VM2472A0	BL SP UPPER CLAMP INT LOCK GLASS SLIDER	1	PZ	VM2473A0	BL SP INT GLASS HINGE LOWER LOCK PIN	1	PZ	VM2474A0	BL SP INT GLASS HINGE UPPER LOCK PIN	1	PZ	VM2479A0	BL SP GLASS H6 PUSHING BRACKET	6	PZ	VM2489A0	SP HANDLE END KIT + STYLUS KIT	1	PZ	VM2504A0	DOWEL TO GUIDE SLIDE SPRING SHOP.PRO	2	PZ	VM2506A0	SP MECH. RIGHT LOWER LATERAL DOOR CAP	1	PZ	VM2507A0	SP MECH. RIGHT UPPER LATERAL DOOR CAP	1	PZ	VM2512A0	BL SP DOOR-MICRO SWITCH SOFT CLOSING	2	PZ	VM2527A0	STYLUS PEN FOR SP	1	PZ	VM2546A0	SHOP PRO PUSH TO CLOSE DOOR HOOK COVER	1	PZ	VM2546A1	SP COVER PUSH-TO-CLO SE DOOR HOO	1	PZ
Code	Description	Qty	UOM																																																																		
VM2468A0	BL SP LEFT UPPER LATERAL DOOR CAP	1	PZ																																																																		
VM2470A0	SLIDE TO FIX INTERNAL GLASS SHOP.PRO	2	PZ																																																																		
VM2471A0	BL SP LOWER CLAMP INT LOCK GLASS SLIDER	1	PZ																																																																		
VM2472A0	BL SP UPPER CLAMP INT LOCK GLASS SLIDER	1	PZ																																																																		
VM2473A0	BL SP INT GLASS HINGE LOWER LOCK PIN	1	PZ																																																																		
VM2474A0	BL SP INT GLASS HINGE UPPER LOCK PIN	1	PZ																																																																		
VM2479A0	BL SP GLASS H6 PUSHING BRACKET	6	PZ																																																																		
VM2489A0	SP HANDLE END KIT + STYLUS KIT	1	PZ																																																																		
VM2504A0	DOWEL TO GUIDE SLIDE SPRING SHOP.PRO	2	PZ																																																																		
VM2506A0	SP MECH. RIGHT LOWER LATERAL DOOR CAP	1	PZ																																																																		
VM2507A0	SP MECH. RIGHT UPPER LATERAL DOOR CAP	1	PZ																																																																		
VM2512A0	BL SP DOOR-MICRO SWITCH SOFT CLOSING	2	PZ																																																																		
VM2527A0	STYLUS PEN FOR SP	1	PZ																																																																		
VM2546A0	SHOP PRO PUSH TO CLOSE DOOR HOOK COVER	1	PZ																																																																		
VM2546A1	SP COVER PUSH-TO-CLO SE DOOR HOO	1	PZ																																																																		



COMPONENT			SPARE PART																																																																							
Code	Description	Image	Code	Description	Components list																																																																					
VT1328A			KDR1364A	BLSP GO-LED-MT CAMILLA EXT DOOR KIT	<table border="1"> <thead> <tr> <th>Code</th> <th>Description</th> <th>Qty</th> <th>UOM</th> </tr> </thead> <tbody> <tr> <td>VM2548A0</td> <td>PUSH-TO-CLO SE DOOR INT PIPE GUIDE</td> <td>1</td> <td>PZ</td> </tr> <tr> <td>VM2548A1</td> <td>PUSH-TO-CLO SE DOOR INT PIPE GUIDE</td> <td>1</td> <td>PZ</td> </tr> <tr> <td>VM2549A0</td> <td>SP PUSH-TO-CLO SE DOOR HANDLE SPRING EYEL</td> <td>2</td> <td>PZ</td> </tr> <tr> <td>VT1328A1</td> <td></td> <td>1</td> <td>PZ</td> </tr> </tbody> </table>	Code	Description	Qty	UOM	VM2548A0	PUSH-TO-CLO SE DOOR INT PIPE GUIDE	1	PZ	VM2548A1	PUSH-TO-CLO SE DOOR INT PIPE GUIDE	1	PZ	VM2549A0	SP PUSH-TO-CLO SE DOOR HANDLE SPRING EYEL	2	PZ	VT1328A1		1	PZ																																																	
			Code	Description	Qty	UOM																																																																				
VM2548A0	PUSH-TO-CLO SE DOOR INT PIPE GUIDE	1	PZ																																																																							
VM2548A1	PUSH-TO-CLO SE DOOR INT PIPE GUIDE	1	PZ																																																																							
VM2549A0	SP PUSH-TO-CLO SE DOOR HANDLE SPRING EYEL	2	PZ																																																																							
VT1328A1		1	PZ																																																																							
KDR1295A	BL SHOP.PRO CAMILLA EXT LEFT DOOR KIT	<table border="1"> <thead> <tr> <th>Code</th> <th>Description</th> <th>Qty</th> <th>UOM</th> </tr> </thead> <tbody> <tr> <td>0B1307B1</td> <td></td> <td>1</td> <td>PZ</td> </tr> <tr> <td>0B1308A0</td> <td></td> <td>1</td> <td>PZ</td> </tr> <tr> <td>0B1323A0</td> <td></td> <td>1</td> <td>PZ</td> </tr> <tr> <td>0B1324A0</td> <td></td> <td>1</td> <td>PZ</td> </tr> <tr> <td>CR1040A0</td> <td>DOOR LATCH FOR EL.MECH. LOCKING SYSTEM</td> <td>1</td> <td>PZ</td> </tr> <tr> <td>ED1240A0</td> <td>TECHNICAL DATA LABEL</td> <td>1</td> <td>PZ</td> </tr> <tr> <td>IP1325B0</td> <td>POLYSTYREN E CORNER PACKING D20</td> <td>1.450</td> <td>PZ</td> </tr> <tr> <td>IP1385A1</td> <td>CORNER POLYSTYREN E PACKING 110X80X2000</td> <td>0.900</td> <td>M</td> </tr> <tr> <td>IP1508A1</td> <td>POLYSTYREN E U SHAPED PROFILE 2000X60X60</td> <td>1.200</td> <td>M</td> </tr> <tr> <td>ML1005A0</td> <td></td> <td>2</td> <td>PZ</td> </tr> <tr> <td>SL1155A1</td> <td>LOCTITE BICOMPONEN T SILICON</td> <td>34</td> <td>ML</td> </tr> <tr> <td>TB1563A0</td> <td>DOOR LATERAL BEAM SP800</td> <td>2</td> <td>PZ</td> </tr> <tr> <td>TB3306A0</td> <td></td> <td>1</td> <td>PZ</td> </tr> <tr> <td>VI1036A0</td> <td>ST STEEL STRIPED THREAD INSERT M10 FTT/C</td> <td>1</td> <td>PZ</td> </tr> <tr> <td>VI1220A1</td> <td>4,2X12 TCB SELF-TAPPIN G SCREW</td> <td>38</td> <td>PZ</td> </tr> <tr> <td>VI1930A0</td> <td>5X25 ST. STEEL SCREW CHIP</td> <td>22</td> <td>PZ</td> </tr> <tr> <td>VM1059A1</td> <td>HEAT SHRINK FILM H800</td> <td>2</td> <td>M</td> </tr> </tbody> </table>	Code	Description	Qty	UOM	0B1307B1		1	PZ	0B1308A0		1	PZ	0B1323A0		1	PZ	0B1324A0		1	PZ	CR1040A0	DOOR LATCH FOR EL.MECH. LOCKING SYSTEM	1	PZ	ED1240A0	TECHNICAL DATA LABEL	1	PZ	IP1325B0	POLYSTYREN E CORNER PACKING D20	1.450	PZ	IP1385A1	CORNER POLYSTYREN E PACKING 110X80X2000	0.900	M	IP1508A1	POLYSTYREN E U SHAPED PROFILE 2000X60X60	1.200	M	ML1005A0		2	PZ	SL1155A1	LOCTITE BICOMPONEN T SILICON	34	ML	TB1563A0	DOOR LATERAL BEAM SP800	2	PZ	TB3306A0		1	PZ	VI1036A0	ST STEEL STRIPED THREAD INSERT M10 FTT/C	1	PZ	VI1220A1	4,2X12 TCB SELF-TAPPIN G SCREW	38	PZ	VI1930A0	5X25 ST. STEEL SCREW CHIP	22	PZ	VM1059A1	HEAT SHRINK FILM H800	2	M
Code	Description	Qty	UOM																																																																							
0B1307B1		1	PZ																																																																							
0B1308A0		1	PZ																																																																							
0B1323A0		1	PZ																																																																							
0B1324A0		1	PZ																																																																							
CR1040A0	DOOR LATCH FOR EL.MECH. LOCKING SYSTEM	1	PZ																																																																							
ED1240A0	TECHNICAL DATA LABEL	1	PZ																																																																							
IP1325B0	POLYSTYREN E CORNER PACKING D20	1.450	PZ																																																																							
IP1385A1	CORNER POLYSTYREN E PACKING 110X80X2000	0.900	M																																																																							
IP1508A1	POLYSTYREN E U SHAPED PROFILE 2000X60X60	1.200	M																																																																							
ML1005A0		2	PZ																																																																							
SL1155A1	LOCTITE BICOMPONEN T SILICON	34	ML																																																																							
TB1563A0	DOOR LATERAL BEAM SP800	2	PZ																																																																							
TB3306A0		1	PZ																																																																							
VI1036A0	ST STEEL STRIPED THREAD INSERT M10 FTT/C	1	PZ																																																																							
VI1220A1	4,2X12 TCB SELF-TAPPIN G SCREW	38	PZ																																																																							
VI1930A0	5X25 ST. STEEL SCREW CHIP	22	PZ																																																																							
VM1059A1	HEAT SHRINK FILM H800	2	M																																																																							



COMPONENT			SPARE PART																																																																		
Code	Description	Image	Code	Description	Components list																																																																
VT1328A			KDR1295A	BL SHOP.PRO CAMILLA EXT LEFT DOOR KIT	<table border="1"> <thead> <tr> <th>Code</th> <th>Description</th> <th>Qty</th> <th>UOM</th> </tr> </thead> <tbody> <tr> <td>VM1209A0</td> <td></td> <td>1</td> <td>PZ</td> </tr> <tr> <td>VM1630A0</td> <td>INTERNAL GLASS PUSHING CAP</td> <td>6</td> <td>PZ</td> </tr> <tr> <td>VM2274A0</td> <td>GROOVED BUSHING</td> <td>1</td> <td>PZ</td> </tr> <tr> <td>VM2275A0</td> <td>SMOOTH BUSHING</td> <td>1</td> <td>PZ</td> </tr> <tr> <td>VM2456A0</td> <td>BAKERLUX SHOP.PRO HANDLE END</td> <td>2</td> <td>PZ</td> </tr> <tr> <td>VM2456A0</td> <td>BAKERLUX SHOP.PRO HANDLE END</td> <td>2</td> <td>PZ</td> </tr> <tr> <td>VM2465A0</td> <td>SP SIDE-OPENIN G DOOR RIGHT LOWER CAP KIT</td> <td>1</td> <td>PZ</td> </tr> <tr> <td>VM2465A0</td> <td>SP SIDE-OPENIN G DOOR RIGHT LOWER CAP KIT</td> <td>1</td> <td>PZ</td> </tr> <tr> <td>VM2466A0</td> <td>BL SP LEFT LOWER LATERAL DOOR CAP</td> <td>1</td> <td>PZ</td> </tr> <tr> <td>VM2466A0</td> <td>BL SP LEFT LOWER LATERAL DOOR CAP</td> <td>1</td> <td>PZ</td> </tr> <tr> <td>VM2467A0</td> <td>SP SIDE-OPENIN G DOOR RIGHT UPPER CAP KIT</td> <td>1</td> <td>PZ</td> </tr> <tr> <td>VM2467A0</td> <td>SP SIDE-OPENIN G DOOR RIGHT UPPER CAP KIT</td> <td>1</td> <td>PZ</td> </tr> <tr> <td>VM2468A0</td> <td>BL SP LEFT UPPER LATERAL DOOR CAP</td> <td>1</td> <td>PZ</td> </tr> <tr> <td>VM2468A0</td> <td>BL SP LEFT UPPER LATERAL DOOR CAP</td> <td>1</td> <td>PZ</td> </tr> <tr> <td>VM2470A0</td> <td>SLIDE TO FIX INTERNAL GLASS SHOP.PRO</td> <td>2</td> <td>PZ</td> </tr> </tbody> </table>	Code	Description	Qty	UOM	VM1209A0		1	PZ	VM1630A0	INTERNAL GLASS PUSHING CAP	6	PZ	VM2274A0	GROOVED BUSHING	1	PZ	VM2275A0	SMOOTH BUSHING	1	PZ	VM2456A0	BAKERLUX SHOP.PRO HANDLE END	2	PZ	VM2456A0	BAKERLUX SHOP.PRO HANDLE END	2	PZ	VM2465A0	SP SIDE-OPENIN G DOOR RIGHT LOWER CAP KIT	1	PZ	VM2465A0	SP SIDE-OPENIN G DOOR RIGHT LOWER CAP KIT	1	PZ	VM2466A0	BL SP LEFT LOWER LATERAL DOOR CAP	1	PZ	VM2466A0	BL SP LEFT LOWER LATERAL DOOR CAP	1	PZ	VM2467A0	SP SIDE-OPENIN G DOOR RIGHT UPPER CAP KIT	1	PZ	VM2467A0	SP SIDE-OPENIN G DOOR RIGHT UPPER CAP KIT	1	PZ	VM2468A0	BL SP LEFT UPPER LATERAL DOOR CAP	1	PZ	VM2468A0	BL SP LEFT UPPER LATERAL DOOR CAP	1	PZ	VM2470A0	SLIDE TO FIX INTERNAL GLASS SHOP.PRO	2	PZ
Code	Description	Qty	UOM																																																																		
VM1209A0		1	PZ																																																																		
VM1630A0	INTERNAL GLASS PUSHING CAP	6	PZ																																																																		
VM2274A0	GROOVED BUSHING	1	PZ																																																																		
VM2275A0	SMOOTH BUSHING	1	PZ																																																																		
VM2456A0	BAKERLUX SHOP.PRO HANDLE END	2	PZ																																																																		
VM2456A0	BAKERLUX SHOP.PRO HANDLE END	2	PZ																																																																		
VM2465A0	SP SIDE-OPENIN G DOOR RIGHT LOWER CAP KIT	1	PZ																																																																		
VM2465A0	SP SIDE-OPENIN G DOOR RIGHT LOWER CAP KIT	1	PZ																																																																		
VM2466A0	BL SP LEFT LOWER LATERAL DOOR CAP	1	PZ																																																																		
VM2466A0	BL SP LEFT LOWER LATERAL DOOR CAP	1	PZ																																																																		
VM2467A0	SP SIDE-OPENIN G DOOR RIGHT UPPER CAP KIT	1	PZ																																																																		
VM2467A0	SP SIDE-OPENIN G DOOR RIGHT UPPER CAP KIT	1	PZ																																																																		
VM2468A0	BL SP LEFT UPPER LATERAL DOOR CAP	1	PZ																																																																		
VM2468A0	BL SP LEFT UPPER LATERAL DOOR CAP	1	PZ																																																																		
VM2470A0	SLIDE TO FIX INTERNAL GLASS SHOP.PRO	2	PZ																																																																		



PLATON SERVICE  
8 (800) 500-34-47  
www.platonservice.com



COMPONENT			SPARE PART																																																																		
Code	Description	Image	Code	Description	Components list																																																																
VT1328A			KDR1295A	BL SHOP.PRO CAMILLA EXT LEFT DOOR KIT	<table border="1"> <thead> <tr> <th>Code</th> <th>Description</th> <th>Qty</th> <th>UOM</th> </tr> </thead> <tbody> <tr> <td>VM2470A0</td> <td>SLIDE TO FIX INTERNAL GLASS SHOP.PRO</td> <td>2</td> <td>PZ</td> </tr> <tr> <td>VM2471A0</td> <td>BL SP LOWER CLAMP INT LOCK GLASS SLIDER</td> <td>1</td> <td>PZ</td> </tr> <tr> <td>VM2471A0</td> <td>BL SP LOWER CLAMP INT LOCK GLASS SLIDER</td> <td>1</td> <td>PZ</td> </tr> <tr> <td>VM2472A0</td> <td>BL SP UPPER CLAMP INT LOCK GLASS SLIDER</td> <td>1</td> <td>PZ</td> </tr> <tr> <td>VM2472A0</td> <td>BL SP UPPER CLAMP INT LOCK GLASS SLIDER</td> <td>1</td> <td>PZ</td> </tr> <tr> <td>VM2473A0</td> <td>BL SP INT GLASS HINGE LOWER LOCK PIN</td> <td>1</td> <td>PZ</td> </tr> <tr> <td>VM2473A0</td> <td>BL SP INT GLASS HINGE LOWER LOCK PIN</td> <td>1</td> <td>PZ</td> </tr> <tr> <td>VM2474A0</td> <td>BL SP INT GLASS HINGE UPPER LOCK PIN</td> <td>1</td> <td>PZ</td> </tr> <tr> <td>VM2474A0</td> <td>BL SP INT GLASS HINGE UPPER LOCK PIN</td> <td>1</td> <td>PZ</td> </tr> <tr> <td>VM2479A0</td> <td>BL SP GLASS H6 PUSHING BRACKET</td> <td>6</td> <td>PZ</td> </tr> <tr> <td>VM2479A0</td> <td>BL SP GLASS H6 PUSHING BRACKET</td> <td>6</td> <td>PZ</td> </tr> <tr> <td>VM2489A0</td> <td>SP HANDLE END KIT + STYLUS KIT</td> <td>1</td> <td>PZ</td> </tr> <tr> <td>VM2504A0</td> <td>DOWEL TO GUIDE SLIDE SPRING SHOP.PRO</td> <td>2</td> <td>PZ</td> </tr> <tr> <td>VM2504A0</td> <td>DOWEL TO GUIDE SLIDE SPRING SHOP.PRO</td> <td>2</td> <td>PZ</td> </tr> <tr> <td>VM2527A0</td> <td>STYLUS PEN FOR SP</td> <td>1</td> <td>PZ</td> </tr> </tbody> </table>	Code	Description	Qty	UOM	VM2470A0	SLIDE TO FIX INTERNAL GLASS SHOP.PRO	2	PZ	VM2471A0	BL SP LOWER CLAMP INT LOCK GLASS SLIDER	1	PZ	VM2471A0	BL SP LOWER CLAMP INT LOCK GLASS SLIDER	1	PZ	VM2472A0	BL SP UPPER CLAMP INT LOCK GLASS SLIDER	1	PZ	VM2472A0	BL SP UPPER CLAMP INT LOCK GLASS SLIDER	1	PZ	VM2473A0	BL SP INT GLASS HINGE LOWER LOCK PIN	1	PZ	VM2473A0	BL SP INT GLASS HINGE LOWER LOCK PIN	1	PZ	VM2474A0	BL SP INT GLASS HINGE UPPER LOCK PIN	1	PZ	VM2474A0	BL SP INT GLASS HINGE UPPER LOCK PIN	1	PZ	VM2479A0	BL SP GLASS H6 PUSHING BRACKET	6	PZ	VM2479A0	BL SP GLASS H6 PUSHING BRACKET	6	PZ	VM2489A0	SP HANDLE END KIT + STYLUS KIT	1	PZ	VM2504A0	DOWEL TO GUIDE SLIDE SPRING SHOP.PRO	2	PZ	VM2504A0	DOWEL TO GUIDE SLIDE SPRING SHOP.PRO	2	PZ	VM2527A0	STYLUS PEN FOR SP	1	PZ
Code	Description	Qty	UOM																																																																		
VM2470A0	SLIDE TO FIX INTERNAL GLASS SHOP.PRO	2	PZ																																																																		
VM2471A0	BL SP LOWER CLAMP INT LOCK GLASS SLIDER	1	PZ																																																																		
VM2471A0	BL SP LOWER CLAMP INT LOCK GLASS SLIDER	1	PZ																																																																		
VM2472A0	BL SP UPPER CLAMP INT LOCK GLASS SLIDER	1	PZ																																																																		
VM2472A0	BL SP UPPER CLAMP INT LOCK GLASS SLIDER	1	PZ																																																																		
VM2473A0	BL SP INT GLASS HINGE LOWER LOCK PIN	1	PZ																																																																		
VM2473A0	BL SP INT GLASS HINGE LOWER LOCK PIN	1	PZ																																																																		
VM2474A0	BL SP INT GLASS HINGE UPPER LOCK PIN	1	PZ																																																																		
VM2474A0	BL SP INT GLASS HINGE UPPER LOCK PIN	1	PZ																																																																		
VM2479A0	BL SP GLASS H6 PUSHING BRACKET	6	PZ																																																																		
VM2479A0	BL SP GLASS H6 PUSHING BRACKET	6	PZ																																																																		
VM2489A0	SP HANDLE END KIT + STYLUS KIT	1	PZ																																																																		
VM2504A0	DOWEL TO GUIDE SLIDE SPRING SHOP.PRO	2	PZ																																																																		
VM2504A0	DOWEL TO GUIDE SLIDE SPRING SHOP.PRO	2	PZ																																																																		
VM2527A0	STYLUS PEN FOR SP	1	PZ																																																																		



COMPONENT			SPARE PART																																																																																							
Code	Description	Image	Code	Description	Components list																																																																																					
VT1328A			KDR1295A	BL SHOP.PRO CAMILLA EXT LEFT DOOR KIT	<table border="1"> <thead> <tr> <th>Code</th> <th>Description</th> <th>Qty</th> <th>UOM</th> </tr> </thead> <tbody> <tr> <td>VT1328A1</td> <td></td> <td>1</td> <td>PZ</td> </tr> <tr> <td>VT1328A1</td> <td></td> <td>1</td> <td>PZ</td> </tr> </tbody> </table>	Code	Description	Qty	UOM	VT1328A1		1	PZ	VT1328A1		1	PZ																																																																									
			Code	Description	Qty	UOM																																																																																				
VT1328A1		1	PZ																																																																																							
VT1328A1		1	PZ																																																																																							
KDR1294A	BL SHOP.PRO CAMILLA EXTERNAL DOOR KIT	<table border="1"> <thead> <tr> <th>Code</th> <th>Description</th> <th>Qty</th> <th>UOM</th> </tr> </thead> <tbody> <tr> <td>0B1305A0</td> <td></td> <td>1</td> <td>PZ</td> </tr> <tr> <td>0B1306A0</td> <td></td> <td>1</td> <td>PZ</td> </tr> <tr> <td>0B1307B1</td> <td></td> <td>1</td> <td>PZ</td> </tr> <tr> <td>0B1308A0</td> <td></td> <td>1</td> <td>PZ</td> </tr> <tr> <td>CR1040A0</td> <td>DOOR LATCH FOR EL.MECH. LOCKING SYSTEM</td> <td>1</td> <td>PZ</td> </tr> <tr> <td>ED1240A0</td> <td>TECHNICAL DATA LABEL</td> <td>1</td> <td>PZ</td> </tr> <tr> <td>IP1325B0</td> <td>POLYSTYREN E CORNER PACKING D20</td> <td>1.450</td> <td>PZ</td> </tr> <tr> <td>IP1385A1</td> <td>CORNER POLYSTYREN E PACKING 110X80X2000</td> <td>0.900</td> <td>M</td> </tr> <tr> <td>IP1508A1</td> <td>POLYSTYREN E U SHAPED PROFILE 2000X60X60</td> <td>1.200</td> <td>M</td> </tr> <tr> <td>ML1005A0</td> <td></td> <td>2</td> <td>PZ</td> </tr> <tr> <td>SL1155A1</td> <td>LOCTITE BICOMPONEN T SILICON</td> <td>34</td> <td>ML</td> </tr> <tr> <td>TB1563A0</td> <td>DOOR LATERAL BEAM SP800</td> <td>2</td> <td>PZ</td> </tr> <tr> <td>TB3306A0</td> <td></td> <td>1</td> <td>PZ</td> </tr> <tr> <td>VI1036A0</td> <td>ST STEEL STRIPED THREAD INSERT M10 FTT/C</td> <td>1</td> <td>PZ</td> </tr> <tr> <td>VI1220A1</td> <td>4,2X12 TCB SELF-TAPPIN G SCREW</td> <td>38</td> <td>PZ</td> </tr> <tr> <td>VI1930A0</td> <td>5X25 ST. STEEL SCREW CHIP</td> <td>22</td> <td>PZ</td> </tr> <tr> <td>VM1059A1</td> <td>HEAT SHRINK FILM H800</td> <td>2</td> <td>M</td> </tr> <tr> <td>VM1209A0</td> <td></td> <td>1</td> <td>PZ</td> </tr> <tr> <td>VM1630A0</td> <td>INTERNAL GLASS PUSHING CAP</td> <td>6</td> <td>PZ</td> </tr> <tr> <td>VM2274A0</td> <td>GROOVED BUSHING</td> <td>1</td> <td>PZ</td> </tr> <tr> <td>VM2275A0</td> <td>SMOOTH BUSHING</td> <td>1</td> <td>PZ</td> </tr> </tbody> </table>	Code	Description	Qty	UOM	0B1305A0		1	PZ	0B1306A0		1	PZ	0B1307B1		1	PZ	0B1308A0		1	PZ	CR1040A0	DOOR LATCH FOR EL.MECH. LOCKING SYSTEM	1	PZ	ED1240A0	TECHNICAL DATA LABEL	1	PZ	IP1325B0	POLYSTYREN E CORNER PACKING D20	1.450	PZ	IP1385A1	CORNER POLYSTYREN E PACKING 110X80X2000	0.900	M	IP1508A1	POLYSTYREN E U SHAPED PROFILE 2000X60X60	1.200	M	ML1005A0		2	PZ	SL1155A1	LOCTITE BICOMPONEN T SILICON	34	ML	TB1563A0	DOOR LATERAL BEAM SP800	2	PZ	TB3306A0		1	PZ	VI1036A0	ST STEEL STRIPED THREAD INSERT M10 FTT/C	1	PZ	VI1220A1	4,2X12 TCB SELF-TAPPIN G SCREW	38	PZ	VI1930A0	5X25 ST. STEEL SCREW CHIP	22	PZ	VM1059A1	HEAT SHRINK FILM H800	2	M	VM1209A0		1	PZ	VM1630A0	INTERNAL GLASS PUSHING CAP	6	PZ	VM2274A0	GROOVED BUSHING	1	PZ	VM2275A0	SMOOTH BUSHING	1	PZ
Code	Description	Qty	UOM																																																																																							
0B1305A0		1	PZ																																																																																							
0B1306A0		1	PZ																																																																																							
0B1307B1		1	PZ																																																																																							
0B1308A0		1	PZ																																																																																							
CR1040A0	DOOR LATCH FOR EL.MECH. LOCKING SYSTEM	1	PZ																																																																																							
ED1240A0	TECHNICAL DATA LABEL	1	PZ																																																																																							
IP1325B0	POLYSTYREN E CORNER PACKING D20	1.450	PZ																																																																																							
IP1385A1	CORNER POLYSTYREN E PACKING 110X80X2000	0.900	M																																																																																							
IP1508A1	POLYSTYREN E U SHAPED PROFILE 2000X60X60	1.200	M																																																																																							
ML1005A0		2	PZ																																																																																							
SL1155A1	LOCTITE BICOMPONEN T SILICON	34	ML																																																																																							
TB1563A0	DOOR LATERAL BEAM SP800	2	PZ																																																																																							
TB3306A0		1	PZ																																																																																							
VI1036A0	ST STEEL STRIPED THREAD INSERT M10 FTT/C	1	PZ																																																																																							
VI1220A1	4,2X12 TCB SELF-TAPPIN G SCREW	38	PZ																																																																																							
VI1930A0	5X25 ST. STEEL SCREW CHIP	22	PZ																																																																																							
VM1059A1	HEAT SHRINK FILM H800	2	M																																																																																							
VM1209A0		1	PZ																																																																																							
VM1630A0	INTERNAL GLASS PUSHING CAP	6	PZ																																																																																							
VM2274A0	GROOVED BUSHING	1	PZ																																																																																							
VM2275A0	SMOOTH BUSHING	1	PZ																																																																																							





COMPONENT			SPARE PART																																																										
Code	Description	Image	Code	Description	Components list																																																								
VT1328A			KDR1294A	BL SHOP.PRO CAMILLA EXTERNAL DOOR KIT	<table border="1"> <thead> <tr> <th>Code</th> <th>Description</th> <th>Qty</th> <th>UOM</th> </tr> </thead> <tbody> <tr> <td>VM2456A0</td> <td>BAKERLUX SHOP.PRO HANDLE END</td> <td>2</td> <td>PZ</td> </tr> <tr> <td>VM2456A0</td> <td>BAKERLUX SHOP.PRO HANDLE END</td> <td>2</td> <td>PZ</td> </tr> <tr> <td>VM2465A0</td> <td>SP SIDE-OPENIN G DOOR RIGHT LOWER CAP KIT</td> <td>1</td> <td>PZ</td> </tr> <tr> <td>VM2465A0</td> <td>SP SIDE-OPENIN G DOOR RIGHT LOWER CAP KIT</td> <td>1</td> <td>PZ</td> </tr> <tr> <td>VM2466A0</td> <td>BL SP LEFT LOWER LATERAL DOOR CAP</td> <td>1</td> <td>PZ</td> </tr> <tr> <td>VM2466A0</td> <td>BL SP LEFT LOWER LATERAL DOOR CAP</td> <td>1</td> <td>PZ</td> </tr> <tr> <td>VM2467A0</td> <td>SP SIDE-OPENIN G DOOR RIGHT UPPER CAP KIT</td> <td>1</td> <td>PZ</td> </tr> <tr> <td>VM2467A0</td> <td>SP SIDE-OPENIN G DOOR RIGHT UPPER CAP KIT</td> <td>1</td> <td>PZ</td> </tr> <tr> <td>VM2468A0</td> <td>BL SP LEFT UPPER LATERAL DOOR CAP</td> <td>1</td> <td>PZ</td> </tr> <tr> <td>VM2468A0</td> <td>BL SP LEFT UPPER LATERAL DOOR CAP</td> <td>1</td> <td>PZ</td> </tr> <tr> <td>VM2470A0</td> <td>SLIDE TO FIX INTERNAL GLASS SHOP.PRO</td> <td>2</td> <td>PZ</td> </tr> <tr> <td>VM2470A0</td> <td>SLIDE TO FIX INTERNAL GLASS SHOP.PRO</td> <td>2</td> <td>PZ</td> </tr> <tr> <td>VM2471A0</td> <td>BL SP LOWER CLAMP INT LOCK GLASS SLIDER</td> <td>1</td> <td>PZ</td> </tr> </tbody> </table>	Code	Description	Qty	UOM	VM2456A0	BAKERLUX SHOP.PRO HANDLE END	2	PZ	VM2456A0	BAKERLUX SHOP.PRO HANDLE END	2	PZ	VM2465A0	SP SIDE-OPENIN G DOOR RIGHT LOWER CAP KIT	1	PZ	VM2465A0	SP SIDE-OPENIN G DOOR RIGHT LOWER CAP KIT	1	PZ	VM2466A0	BL SP LEFT LOWER LATERAL DOOR CAP	1	PZ	VM2466A0	BL SP LEFT LOWER LATERAL DOOR CAP	1	PZ	VM2467A0	SP SIDE-OPENIN G DOOR RIGHT UPPER CAP KIT	1	PZ	VM2467A0	SP SIDE-OPENIN G DOOR RIGHT UPPER CAP KIT	1	PZ	VM2468A0	BL SP LEFT UPPER LATERAL DOOR CAP	1	PZ	VM2468A0	BL SP LEFT UPPER LATERAL DOOR CAP	1	PZ	VM2470A0	SLIDE TO FIX INTERNAL GLASS SHOP.PRO	2	PZ	VM2470A0	SLIDE TO FIX INTERNAL GLASS SHOP.PRO	2	PZ	VM2471A0	BL SP LOWER CLAMP INT LOCK GLASS SLIDER	1	PZ
Code	Description	Qty	UOM																																																										
VM2456A0	BAKERLUX SHOP.PRO HANDLE END	2	PZ																																																										
VM2456A0	BAKERLUX SHOP.PRO HANDLE END	2	PZ																																																										
VM2465A0	SP SIDE-OPENIN G DOOR RIGHT LOWER CAP KIT	1	PZ																																																										
VM2465A0	SP SIDE-OPENIN G DOOR RIGHT LOWER CAP KIT	1	PZ																																																										
VM2466A0	BL SP LEFT LOWER LATERAL DOOR CAP	1	PZ																																																										
VM2466A0	BL SP LEFT LOWER LATERAL DOOR CAP	1	PZ																																																										
VM2467A0	SP SIDE-OPENIN G DOOR RIGHT UPPER CAP KIT	1	PZ																																																										
VM2467A0	SP SIDE-OPENIN G DOOR RIGHT UPPER CAP KIT	1	PZ																																																										
VM2468A0	BL SP LEFT UPPER LATERAL DOOR CAP	1	PZ																																																										
VM2468A0	BL SP LEFT UPPER LATERAL DOOR CAP	1	PZ																																																										
VM2470A0	SLIDE TO FIX INTERNAL GLASS SHOP.PRO	2	PZ																																																										
VM2470A0	SLIDE TO FIX INTERNAL GLASS SHOP.PRO	2	PZ																																																										
VM2471A0	BL SP LOWER CLAMP INT LOCK GLASS SLIDER	1	PZ																																																										



COMPONENT			SPARE PART																																																																						
Code	Description	Image	Code	Description	Components list																																																																				
VT1328A			KDR1294A	BL SHOP.PRO CAMILLA EXTERNAL DOOR KIT	<table border="1"> <thead> <tr> <th>Code</th> <th>Description</th> <th>Qty</th> <th>UOM</th> </tr> </thead> <tbody> <tr> <td>VM2471A0</td> <td>BL SP LOWER CLAMP INT LOCK GLASS SLIDER</td> <td>1</td> <td>PZ</td> </tr> <tr> <td>VM2472A0</td> <td>BL SP UPPER CLAMP INT LOCK GLASS SLIDER</td> <td>1</td> <td>PZ</td> </tr> <tr> <td>VM2472A0</td> <td>BL SP UPPER CLAMP INT LOCK GLASS SLIDER</td> <td>1</td> <td>PZ</td> </tr> <tr> <td>VM2473A0</td> <td>BL SP INT GLASS HINGE LOWER LOCK PIN</td> <td>1</td> <td>PZ</td> </tr> <tr> <td>VM2473A0</td> <td>BL SP INT GLASS HINGE LOWER LOCK PIN</td> <td>1</td> <td>PZ</td> </tr> <tr> <td>VM2474A0</td> <td>BL SP INT GLASS HINGE UPPER LOCK PIN</td> <td>1</td> <td>PZ</td> </tr> <tr> <td>VM2474A0</td> <td>BL SP INT GLASS HINGE UPPER LOCK PIN</td> <td>1</td> <td>PZ</td> </tr> <tr> <td>VM2479A0</td> <td>BL SP GLASS H6 PUSHING BRACKET</td> <td>6</td> <td>PZ</td> </tr> <tr> <td>VM2479A0</td> <td>BL SP GLASS H6 PUSHING BRACKET</td> <td>6</td> <td>PZ</td> </tr> <tr> <td>VM2489A0</td> <td>SP HANDLE END KIT + STYLUS KIT</td> <td>1</td> <td>PZ</td> </tr> <tr> <td>VM2504A0</td> <td>DOWEL TO GUIDE SLIDE SPRING SHOP.PRO</td> <td>2</td> <td>PZ</td> </tr> <tr> <td>VM2504A0</td> <td>DOWEL TO GUIDE SLIDE SPRING SHOP.PRO</td> <td>2</td> <td>PZ</td> </tr> <tr> <td>VM2527A0</td> <td>STYLUS PEN FOR SP</td> <td>1</td> <td>PZ</td> </tr> <tr> <td>VT1328A1</td> <td></td> <td></td> <td></td> <td>1</td> <td>PZ</td> </tr> <tr> <td>VT1328A1</td> <td></td> <td></td> <td></td> <td>1</td> <td>PZ</td> </tr> </tbody> </table>	Code	Description	Qty	UOM	VM2471A0	BL SP LOWER CLAMP INT LOCK GLASS SLIDER	1	PZ	VM2472A0	BL SP UPPER CLAMP INT LOCK GLASS SLIDER	1	PZ	VM2472A0	BL SP UPPER CLAMP INT LOCK GLASS SLIDER	1	PZ	VM2473A0	BL SP INT GLASS HINGE LOWER LOCK PIN	1	PZ	VM2473A0	BL SP INT GLASS HINGE LOWER LOCK PIN	1	PZ	VM2474A0	BL SP INT GLASS HINGE UPPER LOCK PIN	1	PZ	VM2474A0	BL SP INT GLASS HINGE UPPER LOCK PIN	1	PZ	VM2479A0	BL SP GLASS H6 PUSHING BRACKET	6	PZ	VM2479A0	BL SP GLASS H6 PUSHING BRACKET	6	PZ	VM2489A0	SP HANDLE END KIT + STYLUS KIT	1	PZ	VM2504A0	DOWEL TO GUIDE SLIDE SPRING SHOP.PRO	2	PZ	VM2504A0	DOWEL TO GUIDE SLIDE SPRING SHOP.PRO	2	PZ	VM2527A0	STYLUS PEN FOR SP	1	PZ	VT1328A1				1	PZ	VT1328A1				1	PZ
Code	Description	Qty	UOM																																																																						
VM2471A0	BL SP LOWER CLAMP INT LOCK GLASS SLIDER	1	PZ																																																																						
VM2472A0	BL SP UPPER CLAMP INT LOCK GLASS SLIDER	1	PZ																																																																						
VM2472A0	BL SP UPPER CLAMP INT LOCK GLASS SLIDER	1	PZ																																																																						
VM2473A0	BL SP INT GLASS HINGE LOWER LOCK PIN	1	PZ																																																																						
VM2473A0	BL SP INT GLASS HINGE LOWER LOCK PIN	1	PZ																																																																						
VM2474A0	BL SP INT GLASS HINGE UPPER LOCK PIN	1	PZ																																																																						
VM2474A0	BL SP INT GLASS HINGE UPPER LOCK PIN	1	PZ																																																																						
VM2479A0	BL SP GLASS H6 PUSHING BRACKET	6	PZ																																																																						
VM2479A0	BL SP GLASS H6 PUSHING BRACKET	6	PZ																																																																						
VM2489A0	SP HANDLE END KIT + STYLUS KIT	1	PZ																																																																						
VM2504A0	DOWEL TO GUIDE SLIDE SPRING SHOP.PRO	2	PZ																																																																						
VM2504A0	DOWEL TO GUIDE SLIDE SPRING SHOP.PRO	2	PZ																																																																						
VM2527A0	STYLUS PEN FOR SP	1	PZ																																																																						
VT1328A1				1	PZ																																																																				
VT1328A1				1	PZ																																																																				





COMPONENT			SPARE PART																																																		
Code	Description	Image	Code	Description	Components list																																																
VT1349A			KVT1349A	BL SP CAMILLA INTERNAL GLASS KI	<table border="1"> <thead> <tr> <th>Code</th> <th>Description</th> <th>Qty</th> <th>UOM</th> </tr> </thead> <tbody> <tr> <td>CR1103A0</td> <td>INTERNAL GLASS ST. STEEL UPPER HINGE</td> <td>1</td> <td>PZ</td> </tr> <tr> <td>CR1104A0</td> <td>INTERNAL GLASS ST. STEEL LOWER HINGE</td> <td>1</td> <td>PZ</td> </tr> <tr> <td>IP1508A1</td> <td>POLYSTYREN E U SHAPED PROFILE 2000X60X60</td> <td>2</td> <td>M</td> </tr> <tr> <td>VI1810A0</td> <td>M6X6 STAINLESS STEEL FLATHEAD SCREW</td> <td>6</td> <td>PZ</td> </tr> <tr> <td>VM1059A1</td> <td>HEAT SHRINK FILM H800</td> <td>1</td> <td>M</td> </tr> <tr> <td>VM2399A0</td> <td>DOOR HINGES HEADLESS SCREWS COVER</td> <td>2</td> <td>PZ</td> </tr> <tr> <td>VM2399A0</td> <td>DOOR HINGES HEADLESS SCREWS COVER</td> <td>2</td> <td>PZ</td> </tr> <tr> <td>VM2476A0</td> <td>BL SP H6 INTERNAL GLASS HINGE GASKET</td> <td>2</td> <td>PZ</td> </tr> <tr> <td>VM2476A0</td> <td>BL SP H6 INTERNAL GLASS HINGE GASKET</td> <td>2</td> <td>PZ</td> </tr> <tr> <td>VT1334A1</td> <td></td> <td>1</td> <td>PZ</td> </tr> <tr> <td>VT1334A1</td> <td></td> <td>1</td> <td>PZ</td> </tr> </tbody> </table>	Code	Description	Qty	UOM	CR1103A0	INTERNAL GLASS ST. STEEL UPPER HINGE	1	PZ	CR1104A0	INTERNAL GLASS ST. STEEL LOWER HINGE	1	PZ	IP1508A1	POLYSTYREN E U SHAPED PROFILE 2000X60X60	2	M	VI1810A0	M6X6 STAINLESS STEEL FLATHEAD SCREW	6	PZ	VM1059A1	HEAT SHRINK FILM H800	1	M	VM2399A0	DOOR HINGES HEADLESS SCREWS COVER	2	PZ	VM2399A0	DOOR HINGES HEADLESS SCREWS COVER	2	PZ	VM2476A0	BL SP H6 INTERNAL GLASS HINGE GASKET	2	PZ	VM2476A0	BL SP H6 INTERNAL GLASS HINGE GASKET	2	PZ	VT1334A1		1	PZ	VT1334A1		1	PZ
Code	Description	Qty	UOM																																																		
CR1103A0	INTERNAL GLASS ST. STEEL UPPER HINGE	1	PZ																																																		
CR1104A0	INTERNAL GLASS ST. STEEL LOWER HINGE	1	PZ																																																		
IP1508A1	POLYSTYREN E U SHAPED PROFILE 2000X60X60	2	M																																																		
VI1810A0	M6X6 STAINLESS STEEL FLATHEAD SCREW	6	PZ																																																		
VM1059A1	HEAT SHRINK FILM H800	1	M																																																		
VM2399A0	DOOR HINGES HEADLESS SCREWS COVER	2	PZ																																																		
VM2399A0	DOOR HINGES HEADLESS SCREWS COVER	2	PZ																																																		
VM2476A0	BL SP H6 INTERNAL GLASS HINGE GASKET	2	PZ																																																		
VM2476A0	BL SP H6 INTERNAL GLASS HINGE GASKET	2	PZ																																																		
VT1334A1		1	PZ																																																		
VT1334A1		1	PZ																																																		
PE2107A	SHOP PRO LED CONTROL BOARD KIT		KPE2107B	BAKERLUX SP LED CONTROL BOARD KIT	<table border="1"> <thead> <tr> <th>Code</th> <th>Description</th> <th>Qty</th> <th>UOM</th> </tr> </thead> <tbody> <tr> <td>PE2107B0</td> <td>SP LED CONTROL BOARD</td> <td>1</td> <td>PZ</td> </tr> <tr> <td>VI1930A0</td> <td>5X25 ST. STEEL SCREW CHIP</td> <td>2</td> <td>PZ</td> </tr> <tr> <td>VM2147A0</td> <td>410X343X15 MM PINK SMOOTH ESD SPONGE</td> <td>1</td> <td>PZ</td> </tr> </tbody> </table>	Code	Description	Qty	UOM	PE2107B0	SP LED CONTROL BOARD	1	PZ	VI1930A0	5X25 ST. STEEL SCREW CHIP	2	PZ	VM2147A0	410X343X15 MM PINK SMOOTH ESD SPONGE	1	PZ																																
Code	Description	Qty	UOM																																																		
PE2107B0	SP LED CONTROL BOARD	1	PZ																																																		
VI1930A0	5X25 ST. STEEL SCREW CHIP	2	PZ																																																		
VM2147A0	410X343X15 MM PINK SMOOTH ESD SPONGE	1	PZ																																																		

COMPONENT			SPARE PART																														
Code	Description	Image	Code	Description	Components list																												
VM2474A	BL SP INT GLASS HINGE UPPER LOCK PIN		KVM2474A	BL SP INT GLASS HINGE UPPER LOCK PIN KIT	<table border="1"> <thead> <tr> <th>Code</th> <th>Description</th> <th>Qty</th> <th>UOM</th> </tr> </thead> <tbody> <tr> <td>VM1224A0</td> <td></td> <td>0.150</td> <td>M</td> </tr> <tr> <td>VM2474A0</td> <td>BL SP INT GLASS HINGE UPPER LOCK PIN</td> <td>1</td> <td>PZ</td> </tr> <tr> <td>VM2474A0</td> <td>BL SP INT GLASS HINGE UPPER LOCK PIN</td> <td>1</td> <td>PZ</td> </tr> </tbody> </table>	Code	Description	Qty	UOM	VM1224A0		0.150	M	VM2474A0	BL SP INT GLASS HINGE UPPER LOCK PIN	1	PZ	VM2474A0	BL SP INT GLASS HINGE UPPER LOCK PIN	1	PZ												
Code	Description	Qty	UOM																														
VM1224A0		0.150	M																														
VM2474A0	BL SP INT GLASS HINGE UPPER LOCK PIN	1	PZ																														
VM2474A0	BL SP INT GLASS HINGE UPPER LOCK PIN	1	PZ																														
VM2468A	BL SP LEFT UPPER LATERAL DOOR CA		KVM2468A	BL SP LEFT UPPER LATERAL DOOR CAP KIT	<table border="1"> <thead> <tr> <th>Code</th> <th>Description</th> <th>Qty</th> <th>UOM</th> </tr> </thead> <tbody> <tr> <td>VM2468A0</td> <td>BL SP LEFT UPPER LATERAL DOOR CAP</td> <td>1</td> <td>PZ</td> </tr> <tr> <td>VM2468A0</td> <td>BL SP LEFT UPPER LATERAL DOOR CAP</td> <td>1</td> <td>PZ</td> </tr> </tbody> </table>	Code	Description	Qty	UOM	VM2468A0	BL SP LEFT UPPER LATERAL DOOR CAP	1	PZ	VM2468A0	BL SP LEFT UPPER LATERAL DOOR CAP	1	PZ																
Code	Description	Qty	UOM																														
VM2468A0	BL SP LEFT UPPER LATERAL DOOR CAP	1	PZ																														
VM2468A0	BL SP LEFT UPPER LATERAL DOOR CAP	1	PZ																														
VM2472A	BL SP UPPER CLAMP INT LOCK GLASS SLIDER		KVM2471A	BL SP INTERNAL GLASS LOCK HOLDER KIT	<table border="1"> <thead> <tr> <th>Code</th> <th>Description</th> <th>Qty</th> <th>UOM</th> </tr> </thead> <tbody> <tr> <td>VM1224A0</td> <td></td> <td>0.150</td> <td>M</td> </tr> <tr> <td>VM2471A0</td> <td>BL SP LOWER CLAMP INT LOCK GLASS SLIDER</td> <td>1</td> <td>PZ</td> </tr> <tr> <td>VM2471A0</td> <td>BL SP LOWER CLAMP INT LOCK GLASS SLIDER</td> <td>1</td> <td>PZ</td> </tr> <tr> <td>VM2472A0</td> <td>BL SP UPPER CLAMP INT LOCK GLASS SLIDER</td> <td>1</td> <td>PZ</td> </tr> <tr> <td>VM2472A0</td> <td>BL SP UPPER CLAMP INT LOCK GLASS SLIDER</td> <td>1</td> <td>PZ</td> </tr> </tbody> </table>	Code	Description	Qty	UOM	VM1224A0		0.150	M	VM2471A0	BL SP LOWER CLAMP INT LOCK GLASS SLIDER	1	PZ	VM2471A0	BL SP LOWER CLAMP INT LOCK GLASS SLIDER	1	PZ	VM2472A0	BL SP UPPER CLAMP INT LOCK GLASS SLIDER	1	PZ	VM2472A0	BL SP UPPER CLAMP INT LOCK GLASS SLIDER	1	PZ				
Code	Description	Qty	UOM																														
VM1224A0		0.150	M																														
VM2471A0	BL SP LOWER CLAMP INT LOCK GLASS SLIDER	1	PZ																														
VM2471A0	BL SP LOWER CLAMP INT LOCK GLASS SLIDER	1	PZ																														
VM2472A0	BL SP UPPER CLAMP INT LOCK GLASS SLIDER	1	PZ																														
VM2472A0	BL SP UPPER CLAMP INT LOCK GLASS SLIDER	1	PZ																														
ML1005A			KVM2470A	BL SHOP.PRO INTERNAL GLASS LOCK 2PCS KIT	<table border="1"> <thead> <tr> <th>Code</th> <th>Description</th> <th>Qty</th> <th>UOM</th> </tr> </thead> <tbody> <tr> <td>ML1005A0</td> <td></td> <td>2</td> <td>PZ</td> </tr> <tr> <td>VM1224A0</td> <td></td> <td>0.200</td> <td>M</td> </tr> <tr> <td>VM2470A0</td> <td>SLIDE TO FIX INTERNAL GLASS SHOP.PRO</td> <td>2</td> <td>PZ</td> </tr> <tr> <td>VM2470A0</td> <td>SLIDE TO FIX INTERNAL GLASS SHOP.PRO</td> <td>2</td> <td>PZ</td> </tr> <tr> <td>VM2504A0</td> <td>DOWEL TO GUIDE SLIDE SPRING SHOP.PRO</td> <td>2</td> <td>PZ</td> </tr> <tr> <td>VM2504A0</td> <td>DOWEL TO GUIDE SLIDE SPRING SHOP.PRO</td> <td>2</td> <td>PZ</td> </tr> </tbody> </table>	Code	Description	Qty	UOM	ML1005A0		2	PZ	VM1224A0		0.200	M	VM2470A0	SLIDE TO FIX INTERNAL GLASS SHOP.PRO	2	PZ	VM2470A0	SLIDE TO FIX INTERNAL GLASS SHOP.PRO	2	PZ	VM2504A0	DOWEL TO GUIDE SLIDE SPRING SHOP.PRO	2	PZ	VM2504A0	DOWEL TO GUIDE SLIDE SPRING SHOP.PRO	2	PZ
Code	Description	Qty	UOM																														
ML1005A0		2	PZ																														
VM1224A0		0.200	M																														
VM2470A0	SLIDE TO FIX INTERNAL GLASS SHOP.PRO	2	PZ																														
VM2470A0	SLIDE TO FIX INTERNAL GLASS SHOP.PRO	2	PZ																														
VM2504A0	DOWEL TO GUIDE SLIDE SPRING SHOP.PRO	2	PZ																														
VM2504A0	DOWEL TO GUIDE SLIDE SPRING SHOP.PRO	2	PZ																														

COMPONENT			SPARE PART																														
Code	Description	Image	Code	Description	Components list																												
VM2504A	DOWEL TO GUIDE SLIDE SPRING SHOP.PRO		KVM2470A	BL SHOP.PRO INTERNAL GLASS LOCK 2PCS KIT	<table border="1"> <thead> <tr> <th>Code</th> <th>Description</th> <th>Qty</th> <th>UOM</th> </tr> </thead> <tbody> <tr> <td>ML1005A0</td> <td></td> <td>2</td> <td>PZ</td> </tr> <tr> <td>VM1224A0</td> <td></td> <td>0.200</td> <td>M</td> </tr> <tr> <td>VM2470A0</td> <td>SLIDE TO FIX INTERNAL GLASS SHOP.PRO</td> <td>2</td> <td>PZ</td> </tr> <tr> <td>VM2470A0</td> <td>SLIDE TO FIX INTERNAL GLASS SHOP.PRO</td> <td>2</td> <td>PZ</td> </tr> <tr> <td>VM2504A0</td> <td>DOWEL TO GUIDE SLIDE SPRING SHOP.PRO</td> <td>2</td> <td>PZ</td> </tr> <tr> <td>VM2504A0</td> <td>DOWEL TO GUIDE SLIDE SPRING SHOP.PRO</td> <td>2</td> <td>PZ</td> </tr> </tbody> </table>	Code	Description	Qty	UOM	ML1005A0		2	PZ	VM1224A0		0.200	M	VM2470A0	SLIDE TO FIX INTERNAL GLASS SHOP.PRO	2	PZ	VM2470A0	SLIDE TO FIX INTERNAL GLASS SHOP.PRO	2	PZ	VM2504A0	DOWEL TO GUIDE SLIDE SPRING SHOP.PRO	2	PZ	VM2504A0	DOWEL TO GUIDE SLIDE SPRING SHOP.PRO	2	PZ
Code	Description	Qty	UOM																														
ML1005A0		2	PZ																														
VM1224A0		0.200	M																														
VM2470A0	SLIDE TO FIX INTERNAL GLASS SHOP.PRO	2	PZ																														
VM2470A0	SLIDE TO FIX INTERNAL GLASS SHOP.PRO	2	PZ																														
VM2504A0	DOWEL TO GUIDE SLIDE SPRING SHOP.PRO	2	PZ																														
VM2504A0	DOWEL TO GUIDE SLIDE SPRING SHOP.PRO	2	PZ																														
VM2470A	SLIDE TO FIX INTERNAL GLASS SHOP.PRO		KVM2470A	BL SHOP.PRO INTERNAL GLASS LOCK 2PCS KIT	<table border="1"> <thead> <tr> <th>Code</th> <th>Description</th> <th>Qty</th> <th>UOM</th> </tr> </thead> <tbody> <tr> <td>ML1005A0</td> <td></td> <td>2</td> <td>PZ</td> </tr> <tr> <td>VM1224A0</td> <td></td> <td>0.200</td> <td>M</td> </tr> <tr> <td>VM2470A0</td> <td>SLIDE TO FIX INTERNAL GLASS SHOP.PRO</td> <td>2</td> <td>PZ</td> </tr> <tr> <td>VM2470A0</td> <td>SLIDE TO FIX INTERNAL GLASS SHOP.PRO</td> <td>2</td> <td>PZ</td> </tr> <tr> <td>VM2504A0</td> <td>DOWEL TO GUIDE SLIDE SPRING SHOP.PRO</td> <td>2</td> <td>PZ</td> </tr> <tr> <td>VM2504A0</td> <td>DOWEL TO GUIDE SLIDE SPRING SHOP.PRO</td> <td>2</td> <td>PZ</td> </tr> </tbody> </table>	Code	Description	Qty	UOM	ML1005A0		2	PZ	VM1224A0		0.200	M	VM2470A0	SLIDE TO FIX INTERNAL GLASS SHOP.PRO	2	PZ	VM2470A0	SLIDE TO FIX INTERNAL GLASS SHOP.PRO	2	PZ	VM2504A0	DOWEL TO GUIDE SLIDE SPRING SHOP.PRO	2	PZ	VM2504A0	DOWEL TO GUIDE SLIDE SPRING SHOP.PRO	2	PZ
Code	Description	Qty	UOM																														
ML1005A0		2	PZ																														
VM1224A0		0.200	M																														
VM2470A0	SLIDE TO FIX INTERNAL GLASS SHOP.PRO	2	PZ																														
VM2470A0	SLIDE TO FIX INTERNAL GLASS SHOP.PRO	2	PZ																														
VM2504A0	DOWEL TO GUIDE SLIDE SPRING SHOP.PRO	2	PZ																														
VM2504A0	DOWEL TO GUIDE SLIDE SPRING SHOP.PRO	2	PZ																														
VM2507A	SP MECH. RIGHT UPPER LATERAL DOOR CAP		KVM2507A	BLSP MEC RIGHT UPPER LAT DOOR CAP KIT	<table border="1"> <thead> <tr> <th>Code</th> <th>Description</th> <th>Qty</th> <th>UOM</th> </tr> </thead> <tbody> <tr> <td>VM1224A0</td> <td></td> <td>0.300</td> <td>M</td> </tr> <tr> <td>VM2507A0</td> <td>SP MECH. RIGHT UPPER LATERAL DOOR CAP</td> <td>1</td> <td>PZ</td> </tr> </tbody> </table>	Code	Description	Qty	UOM	VM1224A0		0.300	M	VM2507A0	SP MECH. RIGHT UPPER LATERAL DOOR CAP	1	PZ																
Code	Description	Qty	UOM																														
VM1224A0		0.300	M																														
VM2507A0	SP MECH. RIGHT UPPER LATERAL DOOR CAP	1	PZ																														

COMPONENT			SPARE PART																														
Code	Description	Image	Code	Description	Components list																												
VM2473A	BL SP INT GLASS HINGE LOWER LOCK PIN		KVM2473A	BL SP INT GLASS HINGE LOWER LOCK PIN KIT	<table border="1"> <thead> <tr> <th>Code</th> <th>Description</th> <th>Qty</th> <th>UOM</th> </tr> </thead> <tbody> <tr> <td>VM1224A0</td> <td></td> <td>0.150</td> <td>M</td> </tr> <tr> <td>VM2473A0</td> <td>BL SP INT GLASS HINGE LOWER LOCK PIN</td> <td>1</td> <td>PZ</td> </tr> <tr> <td>VM2473A0</td> <td>BL SP INT GLASS HINGE LOWER LOCK PIN</td> <td>1</td> <td>PZ</td> </tr> </tbody> </table>	Code	Description	Qty	UOM	VM1224A0		0.150	M	VM2473A0	BL SP INT GLASS HINGE LOWER LOCK PIN	1	PZ	VM2473A0	BL SP INT GLASS HINGE LOWER LOCK PIN	1	PZ												
Code	Description	Qty	UOM																														
VM1224A0		0.150	M																														
VM2473A0	BL SP INT GLASS HINGE LOWER LOCK PIN	1	PZ																														
VM2473A0	BL SP INT GLASS HINGE LOWER LOCK PIN	1	PZ																														
VM2466A	BL SP LEFT LOWER LATERAL DOOR CA		KVM2466A	BL SP LEFT LOWER LATERAL DOOR CAP KIT	<table border="1"> <thead> <tr> <th>Code</th> <th>Description</th> <th>Qty</th> <th>UOM</th> </tr> </thead> <tbody> <tr> <td>VM2466A0</td> <td>BL SP LEFT LOWER LATERAL DOOR CAP</td> <td>1</td> <td>PZ</td> </tr> <tr> <td>VM2466A0</td> <td>BL SP LEFT LOWER LATERAL DOOR CAP</td> <td>1</td> <td>PZ</td> </tr> </tbody> </table>	Code	Description	Qty	UOM	VM2466A0	BL SP LEFT LOWER LATERAL DOOR CAP	1	PZ	VM2466A0	BL SP LEFT LOWER LATERAL DOOR CAP	1	PZ																
Code	Description	Qty	UOM																														
VM2466A0	BL SP LEFT LOWER LATERAL DOOR CAP	1	PZ																														
VM2466A0	BL SP LEFT LOWER LATERAL DOOR CAP	1	PZ																														
VM2471A	BL SP LOWER CLAMP INT LOCK GLASS SLIDER		KVM2471A	BL SP INTERNAL GLASS LOCK HOLDER KIT	<table border="1"> <thead> <tr> <th>Code</th> <th>Description</th> <th>Qty</th> <th>UOM</th> </tr> </thead> <tbody> <tr> <td>VM1224A0</td> <td></td> <td>0.150</td> <td>M</td> </tr> <tr> <td>VM2471A0</td> <td>BL SP LOWER CLAMP INT LOCK GLASS SLIDER</td> <td>1</td> <td>PZ</td> </tr> <tr> <td>VM2471A0</td> <td>BL SP LOWER CLAMP INT LOCK GLASS SLIDER</td> <td>1</td> <td>PZ</td> </tr> <tr> <td>VM2472A0</td> <td>BL SP UPPER CLAMP INT LOCK GLASS SLIDER</td> <td>1</td> <td>PZ</td> </tr> <tr> <td>VM2472A0</td> <td>BL SP UPPER CLAMP INT LOCK GLASS SLIDER</td> <td>1</td> <td>PZ</td> </tr> </tbody> </table>	Code	Description	Qty	UOM	VM1224A0		0.150	M	VM2471A0	BL SP LOWER CLAMP INT LOCK GLASS SLIDER	1	PZ	VM2471A0	BL SP LOWER CLAMP INT LOCK GLASS SLIDER	1	PZ	VM2472A0	BL SP UPPER CLAMP INT LOCK GLASS SLIDER	1	PZ	VM2472A0	BL SP UPPER CLAMP INT LOCK GLASS SLIDER	1	PZ				
Code	Description	Qty	UOM																														
VM1224A0		0.150	M																														
VM2471A0	BL SP LOWER CLAMP INT LOCK GLASS SLIDER	1	PZ																														
VM2471A0	BL SP LOWER CLAMP INT LOCK GLASS SLIDER	1	PZ																														
VM2472A0	BL SP UPPER CLAMP INT LOCK GLASS SLIDER	1	PZ																														
VM2472A0	BL SP UPPER CLAMP INT LOCK GLASS SLIDER	1	PZ																														
ML1005A			KVM2470A	BL SHOP.PRO INTERNAL GLASS LOCK 2PCS KIT	<table border="1"> <thead> <tr> <th>Code</th> <th>Description</th> <th>Qty</th> <th>UOM</th> </tr> </thead> <tbody> <tr> <td>ML1005A0</td> <td></td> <td>2</td> <td>PZ</td> </tr> <tr> <td>VM1224A0</td> <td></td> <td>0.200</td> <td>M</td> </tr> <tr> <td>VM2470A0</td> <td>SLIDE TO FIX INTERNAL GLASS SHOP.PRO</td> <td>2</td> <td>PZ</td> </tr> <tr> <td>VM2470A0</td> <td>SLIDE TO FIX INTERNAL GLASS SHOP.PRO</td> <td>2</td> <td>PZ</td> </tr> <tr> <td>VM2504A0</td> <td>DOWEL TO GUIDE SLIDE SPRING SHOP.PRO</td> <td>2</td> <td>PZ</td> </tr> <tr> <td>VM2504A0</td> <td>DOWEL TO GUIDE SLIDE SPRING SHOP.PRO</td> <td>2</td> <td>PZ</td> </tr> </tbody> </table>	Code	Description	Qty	UOM	ML1005A0		2	PZ	VM1224A0		0.200	M	VM2470A0	SLIDE TO FIX INTERNAL GLASS SHOP.PRO	2	PZ	VM2470A0	SLIDE TO FIX INTERNAL GLASS SHOP.PRO	2	PZ	VM2504A0	DOWEL TO GUIDE SLIDE SPRING SHOP.PRO	2	PZ	VM2504A0	DOWEL TO GUIDE SLIDE SPRING SHOP.PRO	2	PZ
Code	Description	Qty	UOM																														
ML1005A0		2	PZ																														
VM1224A0		0.200	M																														
VM2470A0	SLIDE TO FIX INTERNAL GLASS SHOP.PRO	2	PZ																														
VM2470A0	SLIDE TO FIX INTERNAL GLASS SHOP.PRO	2	PZ																														
VM2504A0	DOWEL TO GUIDE SLIDE SPRING SHOP.PRO	2	PZ																														
VM2504A0	DOWEL TO GUIDE SLIDE SPRING SHOP.PRO	2	PZ																														

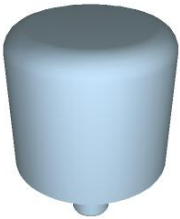
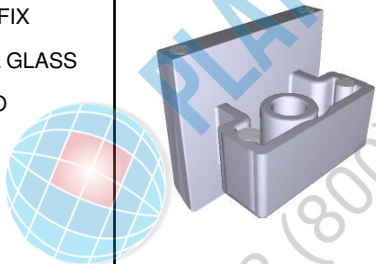
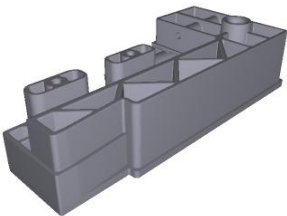
COMPONENT			SPARE PART																														
Code	Description	Image	Code	Description	Components list																												
VM2504A	DOWEL TO GUIDE SLIDE SPRING SHOP.PRO		KVM2470A	BL SHOP.PRO INTERNAL GLASS LOCK 2PCS KIT	<table border="1"> <thead> <tr> <th>Code</th> <th>Description</th> <th>Qty</th> <th>UOM</th> </tr> </thead> <tbody> <tr> <td>ML1005A0</td> <td></td> <td>2</td> <td>PZ</td> </tr> <tr> <td>VM1224A0</td> <td></td> <td>0.200</td> <td>M</td> </tr> <tr> <td>VM2470A0</td> <td>SLIDE TO FIX INTERNAL GLASS SHOP.PRO</td> <td>2</td> <td>PZ</td> </tr> <tr> <td>VM2470A0</td> <td>SLIDE TO FIX INTERNAL GLASS SHOP.PRO</td> <td>2</td> <td>PZ</td> </tr> <tr> <td>VM2504A0</td> <td>DOWEL TO GUIDE SLIDE SPRING SHOP.PRO</td> <td>2</td> <td>PZ</td> </tr> <tr> <td>VM2504A0</td> <td>DOWEL TO GUIDE SLIDE SPRING SHOP.PRO</td> <td>2</td> <td>PZ</td> </tr> </tbody> </table>	Code	Description	Qty	UOM	ML1005A0		2	PZ	VM1224A0		0.200	M	VM2470A0	SLIDE TO FIX INTERNAL GLASS SHOP.PRO	2	PZ	VM2470A0	SLIDE TO FIX INTERNAL GLASS SHOP.PRO	2	PZ	VM2504A0	DOWEL TO GUIDE SLIDE SPRING SHOP.PRO	2	PZ	VM2504A0	DOWEL TO GUIDE SLIDE SPRING SHOP.PRO	2	PZ
Code	Description	Qty	UOM																														
ML1005A0		2	PZ																														
VM1224A0		0.200	M																														
VM2470A0	SLIDE TO FIX INTERNAL GLASS SHOP.PRO	2	PZ																														
VM2470A0	SLIDE TO FIX INTERNAL GLASS SHOP.PRO	2	PZ																														
VM2504A0	DOWEL TO GUIDE SLIDE SPRING SHOP.PRO	2	PZ																														
VM2504A0	DOWEL TO GUIDE SLIDE SPRING SHOP.PRO	2	PZ																														
VM2470A	SLIDE TO FIX INTERNAL GLASS SHOP.PRO		KVM2470A	BL SHOP.PRO INTERNAL GLASS LOCK 2PCS KIT	<table border="1"> <thead> <tr> <th>Code</th> <th>Description</th> <th>Qty</th> <th>UOM</th> </tr> </thead> <tbody> <tr> <td>ML1005A0</td> <td></td> <td>2</td> <td>PZ</td> </tr> <tr> <td>VM1224A0</td> <td></td> <td>0.200</td> <td>M</td> </tr> <tr> <td>VM2470A0</td> <td>SLIDE TO FIX INTERNAL GLASS SHOP.PRO</td> <td>2</td> <td>PZ</td> </tr> <tr> <td>VM2470A0</td> <td>SLIDE TO FIX INTERNAL GLASS SHOP.PRO</td> <td>2</td> <td>PZ</td> </tr> <tr> <td>VM2504A0</td> <td>DOWEL TO GUIDE SLIDE SPRING SHOP.PRO</td> <td>2</td> <td>PZ</td> </tr> <tr> <td>VM2504A0</td> <td>DOWEL TO GUIDE SLIDE SPRING SHOP.PRO</td> <td>2</td> <td>PZ</td> </tr> </tbody> </table>	Code	Description	Qty	UOM	ML1005A0		2	PZ	VM1224A0		0.200	M	VM2470A0	SLIDE TO FIX INTERNAL GLASS SHOP.PRO	2	PZ	VM2470A0	SLIDE TO FIX INTERNAL GLASS SHOP.PRO	2	PZ	VM2504A0	DOWEL TO GUIDE SLIDE SPRING SHOP.PRO	2	PZ	VM2504A0	DOWEL TO GUIDE SLIDE SPRING SHOP.PRO	2	PZ
Code	Description	Qty	UOM																														
ML1005A0		2	PZ																														
VM1224A0		0.200	M																														
VM2470A0	SLIDE TO FIX INTERNAL GLASS SHOP.PRO	2	PZ																														
VM2470A0	SLIDE TO FIX INTERNAL GLASS SHOP.PRO	2	PZ																														
VM2504A0	DOWEL TO GUIDE SLIDE SPRING SHOP.PRO	2	PZ																														
VM2504A0	DOWEL TO GUIDE SLIDE SPRING SHOP.PRO	2	PZ																														
VM2506A	SP MECH. RIGHT LOWER LATERAL DOOR CAP		KVM2506A	BLSP MEC RIGHT LOWER LAT DOOR CAP KIT	<table border="1"> <thead> <tr> <th>Code</th> <th>Description</th> <th>Qty</th> <th>UOM</th> </tr> </thead> <tbody> <tr> <td>VM1224A0</td> <td></td> <td>0.300</td> <td>M</td> </tr> <tr> <td>VM2506A0</td> <td>SP MECH. RIGHT LOWER LATERAL DOOR CAP</td> <td>1</td> <td>PZ</td> </tr> </tbody> </table>	Code	Description	Qty	UOM	VM1224A0		0.300	M	VM2506A0	SP MECH. RIGHT LOWER LATERAL DOOR CAP	1	PZ																
Code	Description	Qty	UOM																														
VM1224A0		0.300	M																														
VM2506A0	SP MECH. RIGHT LOWER LATERAL DOOR CAP	1	PZ																														

COMPONENT			SPARE PART																														
Code	Description	Image	Code	Description	Components list																												
VM2546A	SHOP PRO PUSH TO CLOSE DOOR HOOK COVER		KVM2546A	BLSP COVER PUSH-TO-CLOSE DOOR HOOK KIT	<table border="1"> <thead> <tr> <th>Code</th> <th>Description</th> <th>Qty</th> <th>UOM</th> </tr> </thead> <tbody> <tr> <td>VI1014A0</td> <td>STAINLESS STEEL WASHER 4.5X9X0.8</td> <td>2</td> <td>PZ</td> </tr> <tr> <td>VI1024A0</td> <td>SCREW M4X12 TCB + INOX DIN 7985</td> <td>2</td> <td>PZ</td> </tr> <tr> <td>VM1224A0</td> <td></td> <td>0.200</td> <td>M</td> </tr> <tr> <td>VM2546A0</td> <td>SHOP PRO PUSH TO CLOSE DOOR HOOK COVER</td> <td>1</td> <td>PZ</td> </tr> <tr> <td>VM2546A1</td> <td>SP COVER PUSH-TO-CLOSE DOOR HOO</td> <td>1</td> <td>PZ</td> </tr> </tbody> </table>	Code	Description	Qty	UOM	VI1014A0	STAINLESS STEEL WASHER 4.5X9X0.8	2	PZ	VI1024A0	SCREW M4X12 TCB + INOX DIN 7985	2	PZ	VM1224A0		0.200	M	VM2546A0	SHOP PRO PUSH TO CLOSE DOOR HOOK COVER	1	PZ	VM2546A1	SP COVER PUSH-TO-CLOSE DOOR HOO	1	PZ				
Code	Description	Qty	UOM																														
VI1014A0	STAINLESS STEEL WASHER 4.5X9X0.8	2	PZ																														
VI1024A0	SCREW M4X12 TCB + INOX DIN 7985	2	PZ																														
VM1224A0		0.200	M																														
VM2546A0	SHOP PRO PUSH TO CLOSE DOOR HOOK COVER	1	PZ																														
VM2546A1	SP COVER PUSH-TO-CLOSE DOOR HOO	1	PZ																														
ML1006A	ST STEEL TRACTION SPRING L.21 ED7 DF1		ML1006A0	ST STEEL TRACTION SPRING L.21 ED7 DF1																													
VM2549A	SP PUSH-TO-CLOSE DOOR HANDLE SPRING EYEL		VM2549A0	SP PUSH-TO-CLOSE DOOR HANDLE SPRING EYEL																													
VM2456A	BAKERLUX SHOP.PRO HANDLE END		KVM2456A	2 PCS BAKERLUX SHOP.PRO HANDLE END KIT	<table border="1"> <thead> <tr> <th>Code</th> <th>Description</th> <th>Qty</th> <th>UOM</th> </tr> </thead> <tbody> <tr> <td>VI1930A0</td> <td>5X25 ST. STEEL SCREW CHIP</td> <td>4</td> <td>PZ</td> </tr> <tr> <td>VM1224A0</td> <td></td> <td>0.300</td> <td>M</td> </tr> <tr> <td>VM2456A0</td> <td>BAKERLUX SHOP.PRO HANDLE END</td> <td>2</td> <td>PZ</td> </tr> <tr> <td>VM2456A0</td> <td>BAKERLUX SHOP.PRO HANDLE END</td> <td>2</td> <td>PZ</td> </tr> <tr> <td>VM2489A0</td> <td>SP HANDLE END KIT + STYLUS KIT</td> <td>1</td> <td>PZ</td> </tr> <tr> <td>VM2527A0</td> <td>STYLUS PEN FOR SP</td> <td>1</td> <td>PZ</td> </tr> </tbody> </table>	Code	Description	Qty	UOM	VI1930A0	5X25 ST. STEEL SCREW CHIP	4	PZ	VM1224A0		0.300	M	VM2456A0	BAKERLUX SHOP.PRO HANDLE END	2	PZ	VM2456A0	BAKERLUX SHOP.PRO HANDLE END	2	PZ	VM2489A0	SP HANDLE END KIT + STYLUS KIT	1	PZ	VM2527A0	STYLUS PEN FOR SP	1	PZ
Code	Description	Qty	UOM																														
VI1930A0	5X25 ST. STEEL SCREW CHIP	4	PZ																														
VM1224A0		0.300	M																														
VM2456A0	BAKERLUX SHOP.PRO HANDLE END	2	PZ																														
VM2456A0	BAKERLUX SHOP.PRO HANDLE END	2	PZ																														
VM2489A0	SP HANDLE END KIT + STYLUS KIT	1	PZ																														
VM2527A0	STYLUS PEN FOR SP	1	PZ																														

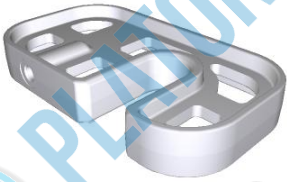
COMPONENT			SPARE PART																														
Code	Description	Image	Code	Description	Components list																												
TB3306A			KTB3306A	BL SHOP.PRO CAMILLA HANDLE TUBE KIT	<table border="1"> <thead> <tr> <th>Code</th> <th>Description</th> <th>Qty</th> <th>UOM</th> </tr> </thead> <tbody> <tr> <td>TB3306A0</td> <td></td> <td>1</td> <td>PZ</td> </tr> <tr> <td>V11930A0</td> <td>5X25 ST. STEEL SCREW CHIP</td> <td>4</td> <td>PZ</td> </tr> <tr> <td>VM2456A0</td> <td>BAKERLUX SHOP.PRO HANDLE END</td> <td>2</td> <td>PZ</td> </tr> <tr> <td>VM2456A0</td> <td>BAKERLUX SHOP.PRO HANDLE END</td> <td>2</td> <td>PZ</td> </tr> <tr> <td>VM2489A0</td> <td>SP HANDLE END KIT + STYLUS KIT</td> <td>1</td> <td>PZ</td> </tr> <tr> <td>VM2527A0</td> <td>STYLUS PEN FOR SP</td> <td>1</td> <td>PZ</td> </tr> </tbody> </table>	Code	Description	Qty	UOM	TB3306A0		1	PZ	V11930A0	5X25 ST. STEEL SCREW CHIP	4	PZ	VM2456A0	BAKERLUX SHOP.PRO HANDLE END	2	PZ	VM2456A0	BAKERLUX SHOP.PRO HANDLE END	2	PZ	VM2489A0	SP HANDLE END KIT + STYLUS KIT	1	PZ	VM2527A0	STYLUS PEN FOR SP	1	PZ
Code	Description	Qty	UOM																														
TB3306A0		1	PZ																														
V11930A0	5X25 ST. STEEL SCREW CHIP	4	PZ																														
VM2456A0	BAKERLUX SHOP.PRO HANDLE END	2	PZ																														
VM2456A0	BAKERLUX SHOP.PRO HANDLE END	2	PZ																														
VM2489A0	SP HANDLE END KIT + STYLUS KIT	1	PZ																														
VM2527A0	STYLUS PEN FOR SP	1	PZ																														
VM2548A	PUSH-TO-CLOSE DOOR INT PIPE GUIDE		KVM2548A	PUSH-TO-CLOSE DOOR INT PIPE GUIDE KIT	<table border="1"> <thead> <tr> <th>Code</th> <th>Description</th> <th>Qty</th> <th>UOM</th> </tr> </thead> <tbody> <tr> <td>ML1006A0</td> <td>ST STEEL TRACTION SPRING L.21 ED7 DF1</td> <td>2</td> <td>PZ</td> </tr> <tr> <td>VM1224A0</td> <td></td> <td>0.200</td> <td>M</td> </tr> <tr> <td>VM2548A0</td> <td>PUSH-TO-CLO SE DOOR INT PIPE GUIDE</td> <td>1</td> <td>PZ</td> </tr> <tr> <td>VM2548A1</td> <td>PUSH-TO-CLO SE DOOR INT PIPE GUIDE</td> <td>1</td> <td>PZ</td> </tr> <tr> <td>VM2549A0</td> <td>SP PUSH-TO-CLO SE DOOR HANDLE SPRING EYEL</td> <td>2</td> <td>PZ</td> </tr> </tbody> </table>	Code	Description	Qty	UOM	ML1006A0	ST STEEL TRACTION SPRING L.21 ED7 DF1	2	PZ	VM1224A0		0.200	M	VM2548A0	PUSH-TO-CLO SE DOOR INT PIPE GUIDE	1	PZ	VM2548A1	PUSH-TO-CLO SE DOOR INT PIPE GUIDE	1	PZ	VM2549A0	SP PUSH-TO-CLO SE DOOR HANDLE SPRING EYEL	2	PZ				
Code	Description	Qty	UOM																														
ML1006A0	ST STEEL TRACTION SPRING L.21 ED7 DF1	2	PZ																														
VM1224A0		0.200	M																														
VM2548A0	PUSH-TO-CLO SE DOOR INT PIPE GUIDE	1	PZ																														
VM2548A1	PUSH-TO-CLO SE DOOR INT PIPE GUIDE	1	PZ																														
VM2549A0	SP PUSH-TO-CLO SE DOOR HANDLE SPRING EYEL	2	PZ																														